

PRODUCTS CATALOGUE

SPLIT • MULTI • OFFICE

2016/2017



www.aircon.pl



Table of contents

MDV BRAND	◀	4 - 7	▶
FUNCTIONS	◀	8 - 11	▶
PORTABLE AIR-CONDITIONERS	◀	13 - 15	▶
SPLIT SERIES	◀	17 - 23	▶
MULTI SERIES	◀	25 - 31	▶
OFFICE STANDARD SERIES	◀	33 - 49	▶
AIR HANDLING UNITS	◀	51 - 57	▶
CONTROL	◀	58 - 65	▶
HRV RECUPERATORS	◀	67 - 77	▶
AIR CURTAINS	◀	79 - 81	▶



Leading manufacturer of air-conditioning unit



Professional brand of air-conditioning appliances belonging to the Midea group. Our product range includes different types and classes of air-conditioning systems with broad applicability. Established in 1999, it comes from commercial products group CAC (Commercial Air-Conditioning). Initially MDV brand was offering modern systems and components dedicated to commercial and industrial applications, e.g. VRF systems, chilled water units and fan-coils or condensing units. In 2001 the company decided to incorporate household air-conditioning solutions to its offer.

Today MDV is one of the most dynamically developing companies in the air-conditioning sector. The company is continually developing new technologies and employs advanced solutions for manufacturing energy-efficient, environmentally friendly, convenient and what is the most important - reliable in operation appliances. The entire production process is closely monitored by the plant's quality control department.

A WORLD LEADER IN AIR-CONDITIONING SOLUTIONS

MDV has been successfully implementing its own solutions worldwide, including:

- Russia,
- Spain,
- Brazil,
- Australia,
- Israel,
- Bulgaria,
- Poland,
- Turkey,
- Saudi Arabia,

consistently expanding its global reach, in order to reinforce the position of the leading air-conditioning solutions provider.

MDV LOGO DEVELOPMENT

The brand image underwent many changes for over 10 years. A new visual identity symbolizes a strong, independent brand, with a unique visual concept, which completely express its dynamic development.



AVAILABLE SERIES OF UNITS



SPLIT

Units intended to be installed on wall. Advantages of this type of air-conditioners are: quiet operation, fast cooling and heating as well as energy saving. Perfect solution for flat or house.

MULTI

One outdoor unit can be connected with 2 or up to 5 indoor units, all of which can operate independently. Connection of one outdoor unit with several indoor units makes it possible to individually cool or heat each room, which entails significant electric energy savings. It is a convenient solution when there is a need for air-conditioning of several living or office spaces.



OFFICE

A wide range of available indoor units designed to achieve optimal cooling and heating capacity and to ensure comfortable working conditions. The products are recommended for all commercial solutions like: office, shop, restaurant.



VRF

Modular air-conditioning system, where many indoor units can be connected to one outdoor unit. Wide selection of indoor units for complete integration into building, while maintaining its internal and external aesthetics at low noise level. VRF systems are ideal for air conditioning in buildings, production and assembly halls, etc.).



Efficient and economical air conditioners,
wide selection of models of various capacities.
Equally suited for cooling and heating.

Buying **MDV** air-conditioning means choosing **high quality product at reasonable price.**

MDV brand strategy:

- Higher capacity, lower energy consumption.
- Environmentally friendly.
- Complete commercial air-conditioning solutions.
- Easy to design.
- Easy installation and maintenance.

MANY REFERENCE SITES ACROSS THE WORLD



Public Administration
Facility in Poland



Rapid railway station in China



University of Edinburgh



Airport in the capital of Mozambique



Airport of Beijing



MDV pays particular attention to the environment protection.

MDV is continuously increasing the level of ecological compatibility, safety and energy efficiency of its systems, involving innovative production technologies. Air-conditioning devices offered by MDV provide high performance, while using much less electric energy. MDV air-conditioners meets requirements of the European ErP Directive. In addition, all devices provide SCOP i SEER coefficients that are consistent with current requirements.

WHAT IS AN ErP?

The European Union enacted the 2009/125/EC Directive, which specifies requirements for electric energy related products. These requirements provide reduction of primary energy consumption and CO2 emission, while increasing the use of energy from renewable sources by 20% (3x20 package). From 1 January 2013, the provisions of the directive apply to all air-conditioning units with up to 12kW cooling/heating capacity, which are used on the European market. Implemented new seasonal energy efficiency coefficients for:

- cooling - SEER (Seasonal Energy Efficiency Ratio);
- heating - SCOP (Seasonal Coefficient Of Performance)

are meant to facilitate customer's choice of the most ecological units. Unit energy efficiency class describes only the performance in specific conditions while, the seasonal efficiency indicates performance in actual operating conditions, which more accurately reflects actual energy consumption.

NEW ENERGY LABELS

The ErP Directive establishes an obligation to apply new product labels, which will help to make informed choices about air-conditioning units and obtain reliable information concerning the purchased device.

All units offered by MDV meet stringent **EU standards.**

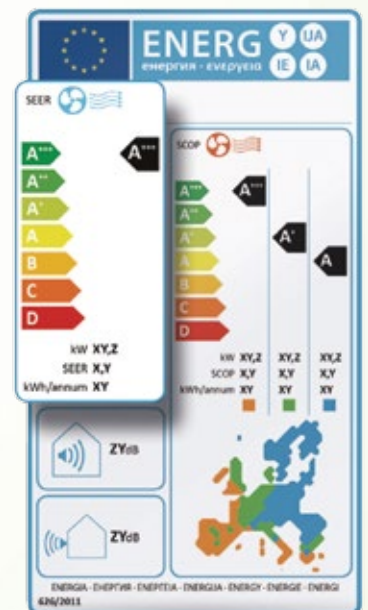

Functions

- ENERGY SAVING
- RELIABILITY
- HEALTH
- COMFORT
- CONVENIENCE



ENERGY SAVING



Economy operation

Enable this function to start air-conditioner operation for 8 hours in economy mode. This results in reduction in energy consumption to even 60% in comparison with operation in the conventional mode.



1 W standby

In the standby mode, by disconnecting power from unused electronic components, the energy consumption is limited to 1W. Compared to conventional devices that consume 5W in the standby mode, you can get up to 80% savings.



Sleep mode

By activation of this function the air-conditioner, during the first two hours of operation, automatically increases (or decreases in heating mode) the set temperature by 1°C every hour, while the fan is set to low speed. After further 5 hours of continuous operation - the air-conditioner turns off. Unnoticed by the user - slow temperature change and automatic unit shut down, guarantee keeping comfort and significant energy savings.

RELIABILITY



Refrigerant Leakage Detect

If the unit detects refrigerant leakage, a message EC will appear on the indoor unit display and the air-conditioner stops operation. This function additionally protects the compressor against damage.



Self-diagnosis and Safety

In the event that failure in operation is encountered, the unit automatically turns off and display relevant error code, what significantly facilitates diagnosis and repair.



Emergency Operation

In case of temperature sensor malfunction, the air-conditioner displays an error code without stopping operation. This enables the air-conditioner to operate in emergency mode until the arrival of service in cases, where the air-conditioning is actually necessary.



Low Ambient Cooling

The built-in low ambient kit adjusts the outdoor unit fan speed to the condensation temperature. This enables cooling operation at external temperatures as low as -15 °C.

HEALTH



High Density Filter

Reduced diameter of the filtration netting mesh is a factor to increase filter efficiency up to 80% in comparison with traditional filters used in other air-conditioners.



Catalyst Filter

A special filter catalytic coating removes formaldehydes and other organic odorous compounds from the air.



Multifunctional Filter

Filter consists of three filtration cartridges with different properties: catalyst filter - removes formaldehydes and odorous compounds; filter with platinum nanoparticles - neutralises allergens and bacteria; filter with vitamin C - enriches the air with vitamin C particles to improve users comfort and well-being.



Silver Ion Filter

Silver ions distributed on a special mesh remove bacteria from air by destroying their cell walls.



Ionizer

By releasing the negative ions it removes odours, smoke and pollens from the air, making it healthier and more comfortable.



Fresh Air

Outdoor air can be supplied to the air-conditioner with use of additional ventilation duct. This provides the necessary oxygen, making the room conditions even more comfortable.

COMFORT



Follow Me Function

In normal conditions, the air-conditioner measures the room temperature by means of the sensor placed inside indoor units body. By activating the Follow Me function, the temperature measurement is performed by the sensor built in the wired or wireless remote controller. This allows to maintain accurate temperature in the user location.



3D Airflow

Automatic louver swing, vertically or horizontally, ensures even temperature distribution in the whole room.



Fast Cooling / Heating

At start-up the compressor rapidly achieves maximum rotations to ensure comfortable room conditions as soon as possible.



Turbo Mode

By activation of this function the fan is started automatically with maximum speed to cool down or heat up the room as soon as possible.



12 Fan Speeds

12 regulation steps of indoor unit fan speed to provide users with the highest comfort.



5 Outdoor Unit Fan Speeds

Applied inverter motor in outdoor unit fan allows to increase the number of available speeds from two to five - which strongly impacts reduction of noise and energy consumption.



Anti-cold Air Function

Air-conditioner starting and fan speed in the heating mode depends on indoor unit heat exchanger temperature. This can prevent cold air blowing out, which avoids the discomfort to the user.



Temperature Compensation

The temperature measured by the sensor placed inside the air-conditioner, depending on the unit installation height, may differ from the temperature at ground level, even by few degrees. The temperature compensation function allows to set appropriate adjustment, to ensure more accurate temperature control and increase the comfort of air-conditioner exploitation.



8°C Heating

The function enables to maintain minimal temperature of 8°C. This can prevent an excessive overcooling of the room while occupants are away in winter season.



Bi-directional Airflow

In cooling mode the louver directs cold airflow not directly at the users, but parallel to the floor level, allowing air to fall with gravity. In heating mode - the flow of warm air is directed downwards. Such solution ensures even temperature distribution in the room and increases comfort.



360° Airflow

Special construction of the cassette air-conditioner panel enables all round airflow in all possible directions, ensuring optimal cooling and heating across the entire room.



Auto Swing

Thanks to the automatic swing of the air louver, we can obtain even distribution of cold or warm air across the entire room.



Mute Operation

User can turn off the acoustic signals emitted by the air-conditioner as well as dim the display, in order to assure undisturbed relax in the room.

CONVENIENCE



Manual Switch

You can easily turn on and off the air-conditioner without the use of a remote controller or any additional tools, but just with the built-in switch.



Remote Switch

Built-in on/off contacts allow remote turning on and off the air-conditioner with use of an additional switch. This contact can also be used for the emergency shutdown of the air-conditioning system, in case of fire alarm, etc.



Wired Controller

The wired controller is permanently attached to the wall, so it is "hard to lose". The controller is especially recommended for commercial spaces. Depending on the model, the wired remote controller has many additional functions that helps keeping the comfortable climate.



Central Controller

The central controller enables you to control up to 64 indoor units. The control can be done individually or in groups. The maximum cable length is 1200 m.



Auto Restart

In case of a power outage, the air-conditioner records all recent settings and automatically restores them when the power comes back.



Louver Position Memory

The air-conditioner stores the recent setting of the air louvers and restores them every time you turn it on.



Timer

This function allows you to program the time of automatic turning on and off the air-conditioner.



Optional condensate drainage connection

Condensate drain pipes can be connected both on the left and right side of the unit, which greatly simplifies installation.



Mono & Multi Compatible

Indoor units can be used individually or in multi systems. This facilitates configuration of the air-conditioning system in buildings with bigger number of room.



Adjustable Static Pressure Switch

By using the switch on the control board of the device it is possible to set manually the external static pressure of the unit.



Built-in Drain Pump

Built-in drain pump with head up to 750 mm, facilitates distribution of condensate drain piping in the space above the false ceiling.



PORTABLE
AIR-CONDITIONERS

nox^a

PORTABLE DEVICES

AIR-CONDITIONER

Noxa

NEW



0.5W IN STANDBY MODE

When the temperature in the room reaches the setpoint temperature, the device will go into the standby mode, resulting in energy consumption reduction.

REVERSE HEAT PUMP

The heat pump system is an excellent alternative to all the traditional electrical heating devices. This ensures lower power consumption while maintaining high heating efficiency. Additionally, by distributing the warm air throughout the whole room it ensures heat comfort that is a lot higher than in case of application of electrical devices.



AIR-CONDITIONER CONTROL PANEL

The air-conditioner can be operated by means of a remote control or a control panel located on the device.

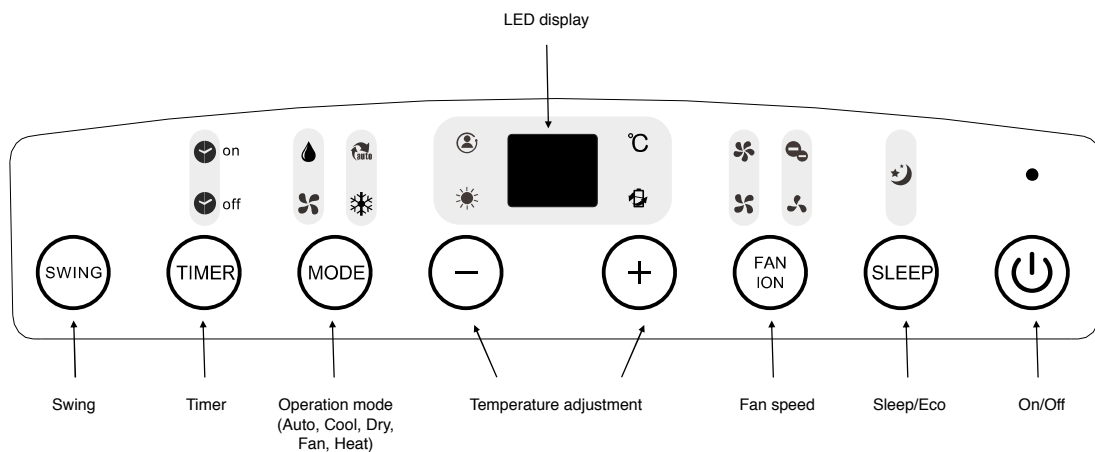

FUNCTIONS

STANDARD



Auto restart



Auto swing



Timer



Self-diagnosis
and safety



Sleep mode



Easy installation



Does not require
condensate drainage



Easy relocation

TECHNICAL DATA

Model			NXM-25APO1-A	NXM-35APO1-A
Type			local reverse heat pump	
Indoor unit power supply (V/phase/Hz)			220-240/1/50	220-240/1/50
Cooling	Rated capacity	kW	2.6	3.5
	Rated input power	W	1010	1350
	Rated current	A	4.4	5.9
	EER	W/W	2.6	2.6
	Energy efficiency class		A	A
Heating	Rated capacity	kW	2.5	2.9
	Rated input power	W	955	1130
	Rated current	A	4.2	5.0
	COP	W/W	2.6	2.6
	Energy efficiency class		A+	A+
Amount of condensate		L/h	1.0	1.2
Internal fan	Airflow rate (low/medium/high)	m ³ /min	5.2/5.3/5.7	5.7/6.1/7.1
	Sound pressure (low/medium/high)	dB(A)	46.0/49.0/52.0	52.4/52.7/53.7
	Sound power at high speed	dB(A)	64	65
Power consumption in stand-by mode		W	0.5	0.5
Refrigerant	Type		R410A	R410A
	Charge	kg	0.44	0.44
Control			wireless remote control	wireless remote control
Fuse		A	16	25
Recommended operation temperature range - ext. temp./int. temp		°C	17-35/5-30	17-35/5-30
Recommended room size		m ²	12-18	16-23
Dimensions (W x D x H)		mm	466x397x765	466x397x765
Shipping dimensions (W x D x H)		mm	515x443x880	515x443x880
Net/gross weight		kg	30.5/34.5	34.0/38.8

The background is a solid purple color with several overlapping, semi-transparent white geometric shapes. These shapes include rounded rectangles and lines that form a complex, abstract pattern. The shapes are layered, creating a sense of depth and movement. The overall aesthetic is modern and minimalist.

SPLIT

SERIES

SPLIT SERIES

WALL-MOUNTED UNITS

Aurora

NEW



HIGH DENSITY FILTERS

High density filters have a significantly more efficient mesh in comparison to standard filters. They remove as much as 80% of pollutants such as dust, pollen or allergens from air, leaving it fresh and clean. It is a perfect solution for people suffering from allergies.

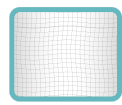
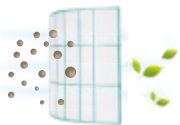

Standard filter
Mesh size:
1.2*1.2mm

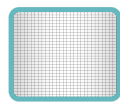

High density filter
Mesh size:
0.54*0.54mm

REFRIGERANT LEAKAGE DETECTION

If the unit detects refrigerant leakage, a message EC will appear on the indoor unit display and the air-conditioner stops operation. This function additionally protects the compressor against damage.

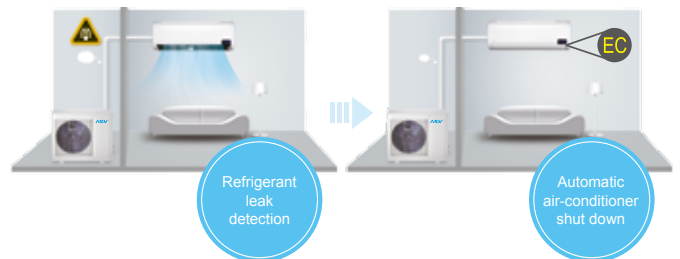

Refrigerant
leak
detection

Automatic
air-conditioner
shut down

LOW AMBIENT COOLING

A special fan speed control system of the outdoor unit ensures appropriate conditions of heat exchange in the cooling operation, even when the external temperature is as low as -15°C.

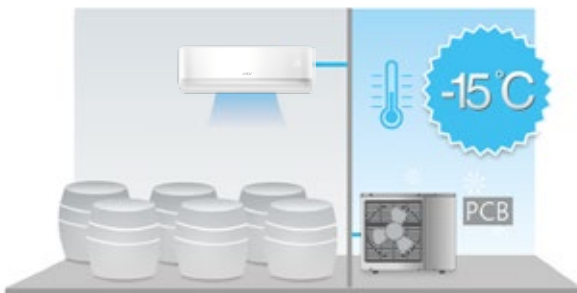

IONIZER

By releasing the negative ions it removes odours, smoke and pollens from the air, making it healthier and more comfortable.



FUNCTIONS

STANDARD

OPTIONAL



Wireless remote control



Auto restart



Refrigerant leakage detect



High density filter



Manual on/off



Display



1 W standby



Low Ambient Cooling



Follow Me



Wired controller



ECO



12 fan speeds



5 outdoor unit fan speeds



Anti-cold Air Function



Optional condensate drainage connection



Mono & Multi



Ionizer

TECHNICAL DATA

Indoor unit				MSABAU-07HRFN1-QRD0GW(B)	MSABAU-09HRFN1-QRD0GW(B)	MSABBU-12HRFN1-QRD0GW(B)	MSABDU-18HRFN1-QRD0GW(B)	MSABEU-24HRFN1-QRD0GW(B)	
Outdoor unit				MOBA30-07HFN1-QRD0GW	MOBA31-09HFN1-QRD0GW	MOB31-12HFN1-QRD0GW	MOB31-18HFN1-QRD0GW	MOCA30-24HFN1-QRD0GW	
Power source (V/phase/Hz)				220-240/1/50					
Cooling	Capacity	Nominal	kW	2.3	2.6	3.5	5.3	7.0	
		Min-Max	kW	1.2~2.9	1.2~3.3	1.4~4.5	1.8~6.2	2.7~8.1	
	Rated input power		kW	0.56	0.75	1.09	1.55	2.26	
	EER		kW/kW	4.12	3.47	3.22	3.43	3.10	
	Design capacity		kW	2.3	2.7	3.5	5.3	7.0	
	Annual energy consumption		kWh/a	103	130	190	268	379	
	SEER			7.9	7.4	6.8	6.8	6.6	
ErP energy efficiency class				A++	A++	A++	A++	A++	
Heating	Capacity	Nominal	kW	2.6	2.9	3.8	5.6	7.9	
		Min-Max	kW	0.9~3.4	0.9~3.8	1.1~4.9	1.4~6.8	2.2~9.3	
	Rated input power		kW	0.63	0.77	1.03	1.50	2.32	
	COP		kW/kW	4.14	3.77	3.71	3.73	3.41	
	Design capacity		kW	2.2	2.6	2.8	4.2	5.6	
	Annual energy consumption		kWh/a	748	659	945	1492	2024	
	SCOP			4.2	4.2	4.2	4.0	4.0	
ErP energy efficiency class				A+	A+	A+	A+	A+	
Maximum current input			A	9.5	9.5	10.0	11.5	17.0	
Indoor unit	Dimensions (W x D x H)		mm	722x187x290	722x187x290	802x189x297	965x215x319	1080x226x335	
	Shipping dimensions (W x D x H)		mm	790x270x370	790x270x370	875x285x375	1045x305x405	1155x415x315	
	Net/Gross weight		kg	7.4/9.6	7.4/9.6	8.2/10.7	10.7/14.0	13.0/16.6	
	Airflow rate (low/medium/high)		m ³ /min	3.8/5.0/6.7	4.0/5.2/7.0	4.5/7.7/8.7	7.0/8.3/12.5	10.2/13.8/17.7	
	Sound pressure level (low/medium/high)		dB(A)	22/31/36	23/33/37	24/35/39	29/34/42	32/43/48	
	Sound power level		dB(A)	52	53	52	57	61	
Outdoor unit	Dimensions (W x D x H)		mm	770x300x555	770x300x555	800x333x554	800x333x554	845x363x702	
	Shipping dimensions (W x D x H)		mm	900x345x585	900x345x585	920x390x615	920x390x615	965x395x755	
	Net/Gross weight		kg	25.2/27.4	26.6/29.0	29.1/31.9	37.8/40.5	48.4/51.6	
	Airflow rate		m ³ /min	30.0	31.7	33.3	35.0	45.0	
	Sound pressure level		dB(A)	52	55	53	55	60	
	Sound power level		dB(A)	57	58	60	62	66	
Refrigerant	Type			R410A	R410A	R410A	R410A	R410A	
	Charge		kg	0.80	0.80	0.95	1.48	2.00	
Piping	Liquid/Gas		mm	Ø6.35 / Ø9.52	Ø6.35 / Ø9.52	Ø6.35 / Ø9.52	Ø6.35 / Ø12.7	Ø9.52 / Ø15.9	
	Maximum length		m	25	25	25	30	50	
	Maximum height difference		m	10	10	10	20	25	
Recommended electric wiring and safety devices	Unit power source/cross-section		mm ²	outdoor / 3x1.5	outdoor / 3x1.5	outdoor / 3x1.5	outdoor / 3x2.5	outdoor / 3x2.5	
	Communication		mm ²	5x1.5	5x1.5	5x1.5	5x1.5	5x2.5	
	Fuse		A	10	10	16	16	20	
Outdoor unit operation temperature range			Cooling	°C					-15 ~ 50
			Heating	°C					-15 ~ 30

The capacity is based on the following conditions:

Cooling: indoor temperature 27°C DB/19°C WB; outdoor temperature 35°C DB/24°C WB

Heating: indoor temperature 20°C DB/15°C WB; outdoor temperature 7°C DB/6°C WB

Piping length: Connected pipes length 7.5 m, height difference 0.



SPLIT SERIES

WALL-MOUNTED UNITS

All Easy



NEW

EASY INSTALLATION

All Easy allows saving time during installation. It is possible thanks to a modified connection terminal, a massive assembly plate and lots of space for piping and cabling.

20%
time saved on
installation



EASY MAINTENANCE

New structure with universal control board - one suits for all the indoor unit sizes. Easy removable PCB and electric components totally save 50% of after service time, offering easy maintenance.

60%
faster board
replacement

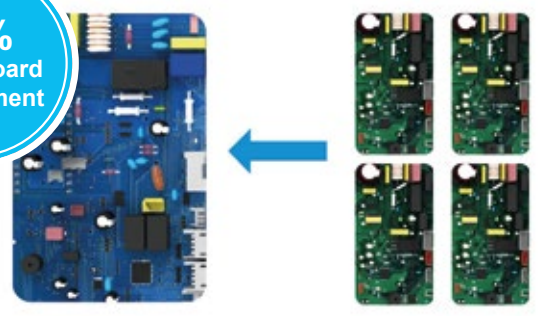

EASY CLEANING

Easy removable filters can be pulled out at the top instead of inside the panel, simplified installation step substantially from 9 steps to 3 steps. All Easy can save totally 50% of cleaning time.

50%
time saved on
cleaning



With All Easy you will save time!

Installation faster by 1.5 h!

FUNCTIONS

STANDARD

OPTIONAL



Wireless remote control



Easy installation



Emergency operation



Silencing



Refrigerant leakage detect



High density filter



Louver position memory



12 fan speeds



Follow Me



WiFi



Alarm port



Manual on/off



1 W standby



Low Ambient Cooling



Two-way condensate drain connection



Mono & Multi



5 fan speeds



Anti-cold Air Function



Auto restart



Wired controller



Central controller

TECHNICAL DATA

Indoor unit				MSAEAU-09HRFN1-QRD0GW	MSAEBU-12HRFN1-QRD0GW	MSAECU-18HRFN1-QRD0GW	MSAEDU-24HRFN1-QRD0GW	
Outdoor unit				MOBA31-09HFN1-QRD0GW	MOB31-12HFN1-QRD0GW	MOB30-18HFN1-QRD0GW	MOCA30-24HFN1-QRD0GW	
Power source (V/phase/Hz)				220-240/1/50				
Cooling	Capacity	Nominal	kW	2.6	3.5	5.3	7.0	
		Min-Max	kW	1.2~3.3	1.3~4.5	1.9~6.1	2.7~7.9	
	Rated input power		kW	0.82	1.15	1.63	2.31	
	EER		kW/kW	3.19	3.04	3.25	3.04	
	Design capacity		kW	2.6	3.5	5.3	7.0	
	Annual energy consumption		kWh/a	134	180	270	374	
	SEER			6.8	6.7	6.8	6.4	
ErP energy efficiency class			A++	A++	A++	A++		
Heating	Capacity	Nominal	kW	2.9	3.8	5.6	7.6	
		Min-Max	kW	0.8~3.7	1.1~4.9	1.4~6.7	2.1~9.1	
	Rated input power		kW	0.81	1.06	1.50	2.30	
	COP		kW/kW	3.58	3.60	3.73	3.30	
	Design capacity		kW	2.4	2.6	4.4	5.6	
	Annual energy consumption		kWh/a	825	884	1514	1980	
	SCOP			4.1	4.2	4.2	4.0	
ErP energy efficiency class			A+	A+	A+	A+		
Maximum current input			A	9.5	10.0	11.5	17.0	
Indoor unit	Dimensions (W x D x H)		mm	717x193x302	805x193x302	964x222x325	1106x232x342	
	Shipping dimensions (W x D x H)		mm	875x375x285	875x375x285	1045x405x305	1195x420x315	
	Net/Gross weight		kg	7.0/9.3	7.7/10.2	10.1/13.6	13.2/17.0	
	Airflow rate (low/medium/high)		m ³ /min	4.2/6.0/7.9	3.7/8.3/9.4	8.3/12.2/14.5	7.4/15.4/19.6	
	Sound pressure level (low/medium/high)		dB(A)	28/35/40	33/40/41	34/43/45	35/45/47	
	Sound power level		dB(A)	53	52	59	61	
Outdoor unit	Dimensions (W x D x H)		mm	770x300x555	800x333x554	800x333x554	845x363x702	
	Shipping dimensions (W x D x H)		mm	900x345x585	920x390x615	920x390x615	965x395x755	
	Net/Gross weight		kg	26.6/29	29.1/31.9	37.8/40.5	48.4/51.6	
	Airflow rate		m ³ /min	31.7	33.3	35.0	45.0	
	Sound pressure level		dB(A)	55	56	58	61	
	Sound power level		dB(A)	58	59	64	65	
Refrigerant	Type			R410A	R410A	R410A	R410A	
	Charge		kg	0.80	0.95	1.48	2.00	
Piping	Liquid/Gas		mm	Ø6.35 / Ø9.52	Ø6.35 / Ø9.52	Ø6.35 / Ø12.7	Ø9.52 / Ø15.9	
	Maximum length		m	25	25	30	50	
	Maximum height difference		m	10	10	20	25	
Recommended electric wiring and safety devices	Unit power source/cross-section		mm ²	outdoor / 3x1.5	outdoor / 3x1.5	outdoor / 3x2.5	outdoor / 3x2.5	
	Communication		mm ²	5x1.5	5x1.5	5x1.5	5x2.5	
	Fuse		A	10	16	16	20	
Outdoor unit operation temperature range			Cooling	°C				-15 ~ 50
			Heating	°C				-15 ~ 30

The capacity is based on the following conditions:

Cooling: indoor temperature 27°C DB/19°C WB; outdoor temperature 35°C DB/24°C WB

Heating: indoor temperature 20°C DB/15°C WB; outdoor temperature 7°C DB/6°C WB

Piping length: Connected pipes length 7.5 m, height difference 0.



SPLIT SERIES

WALL-MOUNTED UNITS

RF



Units available from selected partners of the AIRCON company.

TURBO

By activation of this function the fan is started automatically with maximum speed to cool down or heat up the room as soon as possible.

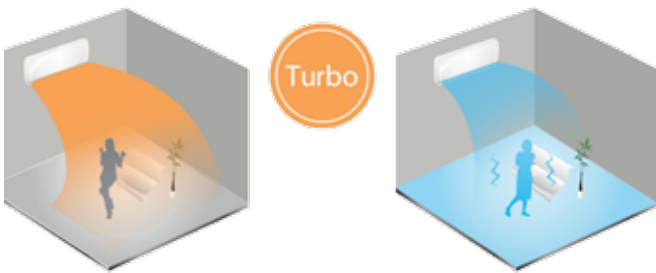

MONO & MULTI INDOOR UNITS

Due to their universal structure, indoor units can be applied either in single or multi split type systems. This simplifies airconditioning systems configuration in buildings, where both solutions are used and at the same time there is a need to apply all indoor units from the same series.

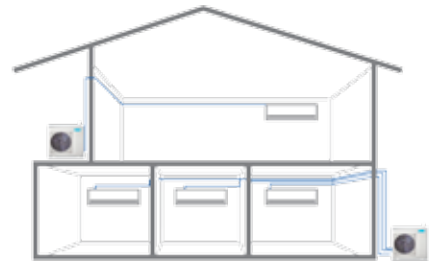

LOUVER POSITION MEMORY

The air-conditioner stores the recent setting of the air louvers and restores them every time you turn it on.

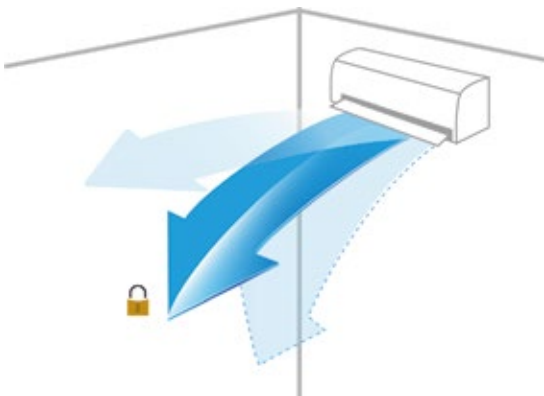

OPTIONAL WALL-MOUNTED CONTROLLER

For user's convenience, in addition to the infrared remote controller, it is possible to use the optional wall mounted controller.



FUNCTIONS

STANDARD

OPTIONAL



Wireless remote control



Louver position memory



Low Ambient Cooling



1 W standby



Anti-cold Air Function



Silencing



Timer



Wired controller



Follow Me



Silver ion filter



Catalyst filter



Emergency operation



Turbo mode



Mono & Multi



Auto restart



12 fan speeds



5 fan speeds



Auto restart



Multifunctional filter

TECHNICAL DATA

Indoor unit				MS12FU-09HRDN1-QRD0GW	MS12FU-12HRDN1-QRD0GW	MS12FU-18HRFN1-QRD0GW	MS12FU-24HRFN1-QRD0GW
Outdoor unit				MOBA30-09HFN1-QRD0GW	MOBA30-12HFN1-QRD0GW	MOB30-18HFN1-QRD0GW	MOCA30-24HFN1-QRD0GW
Power source (V/phase/Hz)				220-240/1/50			
Cooling	Capacity	Nominal	kW	2.6	3.5	5.3	7.0
		Min-Max	kW	1.0~3.2	1.1~4.1	1.8~6.1	2.7~7.9
	Rated input power		kW	0.88	1.26	1.63	2.68
	EER		kW/kW	2.95	2.78	3.26	2.61
	Design capacity		kW	2.6	3.5	5.3	7.0
	Annual energy consumption		kWh/a	161	211	271	392
	SEER			6.1	6.1	6.5	6.3
ErP energy efficiency class			A++	A++	A++	A++	
Heating	Capacity	Nominal	kW	2.9	3.8	5.6	7.3
		Min-Max	kW	0.8~3.4	0.9~4.2	1.4~6.7	1.6~8.8
	Rated input power		kW	0.88	1.15	1.54	2.55
	COP		kW/kW	3.30	3.30	3.63	2.86
	Design capacity		kW	2.5	2.6	4.3	5.5
	Annual energy consumption		kWh/a	873	927	1364	1975
	SCOP			4.0	4.0	4.2	4.0
ErP energy efficiency class			A+	A+	A+	A+	
Maximum current input			A	9.5	10	11.5	17.0
Indoor unit	Dimensions (W x D x H)		mm	715x188x250	800x188x275	940x205x275	1045x235x315
	Shipping dimensions (W x D x H)		mm	775x260x324	865x265x350	1015x265x350	1135x395x315
	Net/Gross weight		kg	6.5/8.2	7.2/9.5	9.0/12.2	12.0/15.2
	Airflow rate (low/medium/high)		m ³ /min	3.8/5.3/7.2	5.7/7.0/8.7	6.0/7.7/10.2	10.8/13.7/16.0
	Sound pressure level (low/medium/high)		dB(A)	25/31/38	26/32/38	23/29/36	31/37/43
	Sound power level		dB(A)	52	53	55	61
Outdoor unit	Dimensions (W x D x H)		mm	770x300x555	770x300x555	800x333x554	845x363x702
	Shipping dimensions (W x D x H)		mm	900x345x585	920x390x615	920x390x615	965x395x755
	Net/Gross weight		kg	26.6/29	25.5/27.7	37.8/40.5	48.4/51.6
	Airflow rate		m ³ /min	30.0	30.0	35.0	45.0
	Sound pressure level		dB(A)	53	55	57	59
	Sound power level		dB(A)	58	60	63	68
Refrigerant	Type			R410A	R410A	R410A	R410A
	Charge		kg	0.8	0.95	1.48	2.00
Piping	Liquid/Gas		mm	Ø6.35 / Ø9.52	Ø6.35 / Ø9.52	Ø6.35 / Ø12.7	Ø9.52 / Ø15.9
	Maximum length		m	25	25	30	50
	Maximum height difference		m	10	10	20	25
Recommended electric wiring and safety devices	Unit power source/cross-section		mm ²	outdoor / 3x1.5	outdoor / 3x1.5	outdoor / 3x2.5	outdoor / 3x2.5
	Communication		mm ²	5x1.5	5x1.5	5x1.5	5x2.5
	Fuse		A	10	16	16	20
Outdoor unit operation temperature range			Cooling	°C	-15 ~ 50		
			Heating	°C	-15 ~ 30		

The capacity is based on the following conditions:

Cooling: indoor temperature 27°C DB/19°C WB; outdoor temperature 35°C DB/24°C WB

Heating: indoor temperature 20°C DB/15°C WB; outdoor temperature 7°C DB/6°C WB

Piping length: Connected pipes length 7.5 m, height difference 0.

The background is a solid purple color with several overlapping white geometric shapes and lines. These shapes include rounded rectangles and hexagons, some of which are nested or overlapping each other. The lines are thin and white, creating a sense of depth and movement. The overall design is modern and minimalist.

MULTI SERIES

MULTI SERIES

OUTDOOR UNITS

MULTI Free Match



FREE MATCH - FLEXIBLE INSTALLATION

One outdoor unit can be connected with up to 5 indoor units. Each indoor unit can be individually controlled. Indoor units do not need to be installed at the same time, what enables system expansion, depending on the user's needs.

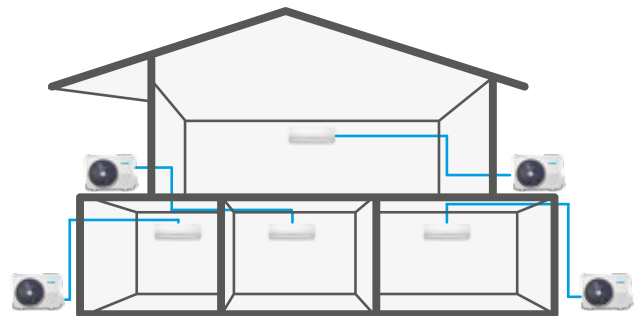
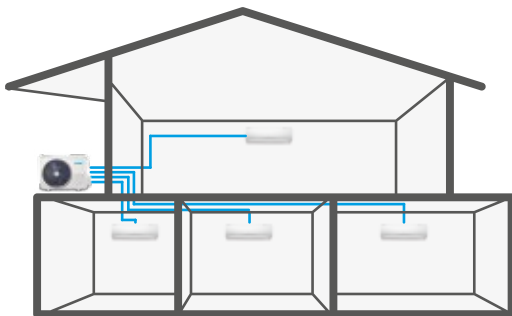

DEDICATED INDOOR UNITS

To a single system it is possible to connect wall-mounted units: All Easy and RF series (efficiency: 2.6-7.0 kW), Aurora series (efficiency: 2.3-7.0 kW) and cassette and duct units (efficiency: 2.1-5.3 kW). The total installation length may reach up to 75 m. This makes the design more flexible and gives many possibilities of air-conditioning system configuration in rooms with variable interior arrangements.



TECHNICAL DATA

			NEW		NEW		NEW			
Outdoor unit			M2OE-16HFN1-Q *	M2OE-18HFN1-Q	M3OE-21HFN1-Q *	M3OE-27HFN1-Q	M4OB-28HFN1-Q	M4OB-36HFN1-Q	M5OE-42HFN1-Q	
Power source (V/phase/Hz)			220-240/1/50							
Cooling	Rated capacity	kW	4.1	5.3	6.2	7.9	8.2	10.6	12.3	
	Rated input power	kW	1.24	1.65	1.92	2.47	2.56	3.63	3.82	
	EER	kW/kW	3.31	3.20	3.21	3.20	3.21	2.91	3.22	
	Design capacity	kW	4.1	5.2	6.1	7.9	8.2	10.6	12.3	
	SEER		6.1	6.1	6.1	6.6	6.8	6.9	6.4	
	ErP energy efficiency class		A++	A++	A++	A++	A++	A++	A++	
Heating	Rated capacity	kW	4.4	5.6	6.6	8.2	8.8	11.1	12.3	
	Rated input power	kW	1.15	1.45	1.78	2.27	2.44	3.17	3.32	
	COP	kW/kW	3.83	3.84	3.70	3.61	3.61	3.51	3.71	
	Design capacity	kW	3.4	4.8	5.6	5.9	7.0	9.3	9.7	
	SCOP		4.0	3.8	3.8	4.0	4.0	3.8	3.5	
	ErP energy efficiency class		A+	A	A	A+	A+	A	A	
Maximum input power	W	2000	2600	2800	3300	3500	4600	4700		
Airflow rate	m ³ /min	25.0	35.0	45.0	58.3	63.3	91.7	91.7		
Sound pressure level	dB(A)	54.0	56.5	57.5	59.5	60	63.5	64.0		
Sound power level	dB(A)	60	65	65	68	66	68	68		
Outdoor unit	Dimensions (W x D x H)	mm	800x333x554	800x333x554	845x363x702	845x363x702	946x410x810	946x410x810	946x410x810	
	Shipping dimensions (W x D x H)	mm	920x390x615	920x390x615	965x395x755	965x395x755	1090x500x865	1090x500x865	1090x500x865	
	Net/Gross weight	kg	30.5/33.5	36.0/39.0	47.0/50.2	52.7/56.1	67.6/73.4	70.0/75.0	76.0/81.0	
Refrigerant	Type		R410A	R410A	R410A	R410A	R410A	R410A	R410A	
	Charge	kg	1.25	1.70	2.10	2.10	2.40	3.00	3.60	
Piping	Liquid/Gas	mm	2x Ø6.35 / Ø9.52	2x Ø6.35 / Ø9.52	3x Ø6.35 / Ø9.52	3x Ø6.35 / Ø9.52	4 x Ø6.35 / 3x Ø9.52 +1x Ø12.7	4 x Ø6.35 / 3x Ø9.52 +1x Ø12.7	5 x Ø6.35 / 4x Ø9.52 +1x Ø12.7	
	Maximum total length	m	30	30	45	45	60	60	75	
	Maximum length to each unit	m	20	20	25	25	30	30	30	
	Max. height difference outdoor - indoor	Outdoor unit above indoor units	m	15	15	15	15	15	15	15
		Outdoor unit below indoor units	m	10	10	10	10	10	10	10
	Max. height difference between internal units	m	10	10	10	10	10	10	10	
Recommended electric wiring and safety devices	Power source	mm ²	3x2.5	3x2.5	3x2.5	3x2.5	3x4.0	3x4.0	3x4.0	
	Communication	mm ²	4x1.5	4x1.5	4x1.5	4x1.5	4x1.5	4x1.5	4x1.5	
	Fuse	A	16	16	20	20	20	25	30	
Outdoor unit operation temperature range	Cooling	°C	-15 ~ 50							
	Heating	°C	-15 ~ 24							

The capacity is based on the following conditions:

Cooling: indoor temperature 27°C DB/19°C WB; outdoor temperature 35°C DB/24°C WB

Heating: indoor temperature 20°C DB/15°C WB; outdoor temperature 7°C DB/6°C WB

Piping length: Connected pipes length 7.5 m, height difference 0.

* Units available from selected partners of the Aircon company

INDOOR UNIT CONNECTION COMBINATION

Cooling capacity 4.1 kW

M2OE-16HFN1-Q	1 UNIT		2 UNITS	
	7	7+7	9+9	
	9	7+9	9+12	
	12	7+12		

Cooling capacity 5.3 kW

M2OE-18HFN1-Q	1 UNIT		2 UNITS	
	7	7+7	9+9	
	9	7+9	9+12	
	12	7+12	9+18	
	18	7+18	12+12	

Cooling capacity 6.2 kW

M3OE-21HFN1-Q	1 UNIT		2 UNITS		3 UNITS	
	7	7+7	9+9	12+18	7+7+7	7+9+12
	9	7+9	9+12		7+7+9	9+9+9
	12	7+12	9+18		7+7+12	9+9+12
	18	7+18	12+12		7+9+9	

Cooling capacity 7.9 kW

M3OE-27HFN1-Q	1 UNIT		2 UNITS		3 UNITS		
	7	7+7	9+9	12+18	7+7+7	7+9+9	9+9+12
	9	7+9	9+12		7+7+9	7+9+12	9+12+12
	12	7+12	9+18		7+7+12	7+12+12	
	18	7+18	12+12		7+7+18	9+9+9	

Cooling capacity 8.2 kW

M4OE-28HFN1-Q	1 UNIT		2 UNITS		3 UNITS			4 UNITS		
	7	7+7	9+12	7+7+7	7+9+12	12+12+12	7+7+7+7	7+7+9+12	7+7+12+12	9+9+9+12
	9	7+9	9+18	7+7+9	7+12+12		7+7+7+9	7+7+12+12	7+7+12+12	
	12	7+12	12+12	7+7+12	9+9+9		7+7+7+12	7+9+9+9	7+9+9+9	
	18	7+18	12+18	7+7+18	9+9+12		7+7+7+18	7+9+9+12	7+9+9+12	
		9+9	18+18	7+9+9	9+12+12		7+7+9+9	9+9+9+9		

Cooling capacity 10.6 kW

M4OB-36HFN1-Q	1 UNIT		2 UNITS		3 UNITS			4 UNITS		
	7	7+7	12+18	7+7+7	7+12+18	12+12+12	7+7+7+7	7+7+12+18	7+12+12+18	12+12+12+12
	9	7+9	18+18	7+7+9	7+18+18	12+12+18	7+7+7+9	7+7+18+18	9+9+9+9	
	12	7+12		7+7+12	9+9+9	12+18+18	7+7+7+12	7+9+9+9	9+9+9+12	
	18	7+18		7+7+18	9+9+12		7+7+7+18	7+9+9+12	9+9+9+18	
		9+9		7+9+9	9+9+18		7+7+9+9	7+9+9+18	9+9+12+12	
		9+12		7+9+12	9+12+12		7+7+9+12	7+9+12+12	9+9+12+18	
		9+18		7+9+18	9+12+18		7+7+9+18	7+9+12+18	9+12+12+12	
	12+12		7+12+12	9+18+18		7+7+12+12	7+12+12+12	9+12+12+18		

Cooling capacity 12.3 kW

M5OE-42HFN1-Q	1 UNIT		2 UNITS		3 UNITS				
	7	7+7	9+18	7+7+7	7+9+18	9+9+12	12+12+12		
	9	7+9	9+24	7+7+9	7+9+24	9+9+18	12+12+18		
	12	7+12	12+12	7+7+12	7+12+12	9+9+24	12+12+24		
	18	7+18	12+18	7+7+18	7+12+18	9+12+12	12+18+18		
	24	7+24	12+24	7+7+24	7+12+24	9+12+18	18+18+18		
		9+9	18+18	7+9+9	7+18+18	9+12+24			
		9+12	18+24	7+9+12	9+9+9	9+18+18			
	4 UNITS				5 UNITS				
	7+7+7+7	7+7+12+18	7+9+12+24	9+9+9+24	12+12+12+18	7+7+7+7+7	7+7+7+12+18	7+7+12+12+12	7+12+12+12+12
	7+7+7+9	7+7+12+24	7+9+18+18	9+9+12+12		7+7+7+7+9	7+7+7+12+24	7+7+12+12+18	9+9+9+9+9
	7+7+7+12	7+7+18+18	7+9+18+24	9+9+12+18		7+7+7+7+12	7+7+7+18+18	7+9+9+9+9	9+9+9+9+12
	7+7+7+18	7+7+18+24	7+12+12+12	9+9+12+24		7+7+7+7+18	7+7+9+9+9	7+9+9+9+12	9+9+9+9+18
	7+7+7+24	7+9+9+9	7+12+12+18	9+9+18+18		7+7+7+7+24	7+7+9+9+12	7+9+9+9+18	9+9+9+12+12
	7+7+9+9	7+9+9+12	7+12+12+24	9+12+12+12		7+7+7+9+9	7+7+9+9+18	7+9+9+9+24	9+9+9+12+18
	7+7+9+12	7+9+9+18	7+12+18+18	9+12+12+18		7+7+7+9+12	7+7+9+9+24	7+9+9+12+12	9+9+12+12+12
	7+7+9+18	7+9+9+24	9+9+9+9	9+12+12+24		7+7+7+9+18	7+7+9+12+12	7+9+9+12+18	9+12+12+12+12
	7+7+9+24	7+9+12+12	9+9+9+12	9+12+18+18		7+7+7+9+24	7+7+9+12+18	7+9+12+12+12	
	7+7+12+12	7+9+12+18	9+9+9+18	12+12+12+12		7+7+7+12+12	7+7+9+18+18	7+9+12+12+18	

WALL-MOUNTED UNITS

Aurora

NEW



Indoor unit			MSABAU-07HRFN1-QRD0GW(B)	MSABAU-09HRFN1-QRD0GW(B)	MSABBU-12HRFN1-QRD0GW(B)	MSABDU-18HRFN1-QRD0GW(B)	MSABEU-24HRFN1-QRD0GW(B)
Power source (V/phase/Hz)			220-240/1/50				
Cooling	Rated capacity	kW	2.3	2.6	3.5	5.3	7.0
	Rated input power	kW	0.56	0.75	1.09	1.55	2.26
Heating	Rated capacity	kW	2.6	2.9	3.8	5.6	7.9
	Rated input power	kW	0.63	0.77	1.03	1.50	2.32
Airflow rate (low/medium/high)		m ³ /h	3.8/5.0/6.7	4.0/5.2/7.0	4.5/7.7/8.7	7.0/8.3/12.5	10.2/13.8/17.7
Sound pressure level (low/medium/high)		dB(A)	22/31/36	23/33/37	24/35/39	29/34/42	32/43/48
Sound power level		dB(A)	52	53	52	57	61
Indoor unit	Dimensions (W x D x H)	mm	722x187x290	722x187x290	802x189x297	965x215x319	1080x226x335
	Shipping dimensions (W x D x H)	mm	790x270x370	790x270x370	875x285x375	1045x305x405	1155x415x315
	Net/Gross weight	kg	7.4/9.6	7.4/9.6	8.2/10.7	10.7/14.0	13.0/16.6
Piping	Liquid	mm	Ø6.35	Ø6.35	Ø6.35	Ø6.35	Ø6.35
	Gas	mm	Ø9.52	Ø9.52	Ø9.52	Ø12.7	Ø15.9

The capacity is based on the following conditions:

Cooling: indoor temperature 27°C DB/19°C WB; outdoor temperature 35°C DB/24°C WB

Heating: indoor temperature 20°C DB/15°C WB; outdoor temperature 7°C DB/6°C WB

Piping length: Connected pipes length 7.5 m, height difference 0.

All Easy

NEW



Indoor unit			MSAEAU-09HRFN1-QRD0GW	MSAEBU-12HRFN1-QRD0GW	MSAECU-18HRFN1-QRD0GW	MSAEDU-24HRFN1-QRD0GW
Power source (V/phase/Hz)			220-240/1/50			
Cooling	Rated capacity	kW	2.6	3.5	5.3	7.0
	Rated input power	kW	0.82	1.15	1.63	2.31
Heating	Rated capacity	kW	2.9	3.8	5.6	7.6
	Rated input power	kW	0.81	1.06	1.50	2.30
Airflow rate (low/medium/high)		m ³ /h	4.2/6.0/7.9	3.7/8.3/9.4	8.3/12.2/14.5	7.4/15.4/19.6
Sound pressure level (low/medium/high)		dB(A)	28/35/40	33/40/41	34/43/45	35/45/47
Sound power level		dB(A)	53	52	59	61
Indoor unit	Dimensions (W x D x H)	mm	717x193x302	805x193x302	964x222x325	1106x232x342
	Shipping dimensions (W x D x H)	mm	875x375x285	875x375x285	1045x405x305	1195x420x315
	Net/Gross weight	kg	7.0/9.3	7.7/10.2	10.1/13.6	13.2/17.0
Piping	Liquid	mm	Ø6.35	Ø6.35	Ø6.35	Ø6.35
	Gas	mm	Ø9.52	Ø9.52	Ø12.7	Ø15.9

The capacity is based on the following conditions:

Cooling: indoor temperature 27°C DB/19°C WB; outdoor temperature 35°C DB/24°C WB

Heating: indoor temperature 20°C DB/15°C WB; outdoor temperature 7°C DB/6°C WB

Piping length: Connected pipes length 7.5 m, height difference 0.

RF



Indoor unit			MS12FU-09HRFN1-QRD0GW	MS12FU-12HRFN1-QRD0GW	MS12FU-18HRFN1-QRD0GW	MS12FU-24HRFN1-QRD0GW
Power source (V/phase/Hz)			220-240/1/50			
Cooling	Rated capacity	kW	2.6	3.5	5.3	7.0
	Rated input power	kW	0.80	1.17	1.63	2.68
Heating	Rated capacity	kW	2.9	3.8	5.6	7.3
	Rated input power	kW	0.92	1.12	1.54	2.55
Airflow rate (low/medium/high)		m ³ /h	3.8/5.3/7.2	5.2/6.5/8.1	6.0/7.7/10.2	10.8/13.7/16.0
Sound pressure level (low/medium/high)		dB(A)	25/31/38	26/32/38	23/29/36	31/37/43
Sound power level		dB(A)	52	53	55	61
Indoor unit	Dimensions (W x D x H)	mm	715x188x250	800x188x275	940x205x275	1045x235x315
	Shipping dimensions (W x D x H)	mm	775x260x324	865x265x350	1015x265x350	1135x395x315
	Net/Gross weight	kg	6.5/8.2	7.4/9.5	9.0/12.2	12.0/15.2
Piping	Liquid	mm	Ø6.35	Ø6.35	Ø6.35	Ø6.35
	Gas	mm	Ø9.52	Ø9.52	Ø12.7	Ø15.9

The capacity is based on the following conditions:

Cooling: indoor temperature 27°C DB/19°C WB; outdoor temperature 35°C DB/24°C WB

Heating: indoor temperature 20°C DB/15°C WB; outdoor temperature 7°C DB/6°C WB

Piping length: Connected pipes length 7.5 m, height difference 0.

CASSETTE UNITS



Indoor unit			MCA3I-07HRFN1-QRC8	MCA3I-09HRFN1-QRC8	MCA3U-12HRFN1-QRDAW	MCA3I-18HRDN1-QRC8
Power source (V/phase/Hz)			220-240/1/50			
Cooling	Rated capacity	kW	2.1	2.6	3.5	5.3
	Rated input power	kW	0.04	0.04	0.04	0.10
	Rated input power	A	0.18	0.18	0.18	0.44
Heating	Rated capacity	kW	2.3	2.9	4.1	5.3
	Rated input power	kW	0.04	0.04	0.04	0.10
	Rated input power	A	0.18	0.18	0.18	0.44
Airflow rate (low/medium/high)		m ³ /h	7.5/8.3/9.7	7.5/8.3/9.7	7.5/8.8/10.0	8.3/10.8/13.3
Sound pressure level (low/medium/high)		dB(A)	35/38/42	33.5/36/39	34/37/41	36/42/48
Sound power level		dB(A)	53	53	58	59
Indoor unit	Dimensions (W x D x H)	mm	570x570x260	570x570x260	570x570x260	570x570x260
	Shipping dimensions (W x D x H)	mm	655x655x290	655x655x290	655x655x290	655x655x290
	Net/Gross weight	kg	14.5/17.3	14.5/17.3	16.0/19.0	18.0/21.0
Panel	Symbol		T-MBQ4-03E	T-MBQ4-03E	T-MBQ4-03E	T-MBQ4-03E
	Dimensions (W x D x H)	mm	647x647x50	647x647x50	647x647x50	647x647x50
	Shipping dimensions (W x D x H)	mm	715x715x123	715x715x123	715x715x123	715x715x123
	Net/Gross weight	kg	2.5/4.5	2.5/4.5	2.5/4.5	2.5/4.5
Cooling pipes	Liquid	mm	Ø6.35	Ø6.35	Ø6.35	Ø6.35
	Gas	mm	Ø9.52	Ø9.52	Ø9.52	Ø12.7

The capacity is based on the following conditions:

Cooling: indoor temperature 27°C DB/19°C WB; outdoor temperature 35°C DB/24°C WB

Heating: indoor temperature 20°C DB/15°C WB; outdoor temperature 7°C DB/6°C WB

Piping length: Connected pipes length 7.5 m, height difference 0.

DUCT UNITS



Indoor unit			MTBI-07HWFN1-QRD0	MTBI-09HWFN1-QRD0	MTBU-12HWFN1-QRDAW	MTBI-18HWDN1-QRC8
Power source (V/phase/Hz)			220-240/1/50			
Cooling	Rated capacity	kW	2.1	2.6	3.5	5.3
	Rated input power	kW	0.03	0.03	0.03	0.10
	Rated input power	A	0.13	0.13	0.13	0.48
Heating	Rated capacity	kW	2.3	2.9	3.8	5.9
	Rated input power	kW	0.03	0.03	0.03	0.10
	Rated input power	A	0.13	0.13	0.13	0.48
Airflow rate (low/medium/high)		m ³ /h	5.7/6.7/8.8	5.7/6.7/9.0	7.5/9.7/11.3	-/9.1/13.6
Sound pressure level (low/medium/high)		dB(A)	31/32/35	28/31/35	35/38/42	40/42/46
Sound power level		dB(A)	55	55	59	59
External static pressure (range)		Pa	0~40	0~40	0~45	0~60
Indoor unit	Dimensions (W x D x H)	mm	700x635x210	700x635x210	700x635x210	920x635x210
	Shipping dimensions (W x D x H)	mm	915x655x290	915x655x290	915x655x290	1135x655x290
	Net/Gross weight	kg	18.5/23.1	18.5/32.1	18.4/22.7	23.0/29.0
Piping	Liquid	mm	Ø6.35	Ø6.35	Ø6.35	Ø6.35
	Gas	mm	Ø9.52	Ø9.52	Ø9.52	Ø12.7

The capacity is based on the following conditions:

Cooling: indoor temperature 27°C DB/19°C WB; outdoor temperature 35°C DB/24°C WB

Heating: indoor temperature 20°C DB/15°C WB; outdoor temperature 7°C DB/6°C WB

Piping length: Connected pipes length 7.5 m, height difference 0.



OFFICE
STANDARD
SERIES



Console



QUIET CONSTRUCTION

Low-speed centrifugal fan with a large diameter, ensures efficient airflow, while still maintaining very low noise level.



OPTIONAL WALL MOUNTED CONTROLLER

For user's convenience, in addition to the infrared remote controller, it is possible to use the optional wall mounted controller.



QUICK COOLING OR HEATING

COOLING MODE



Quick cooling



Maintaining stable temperature

HEATING MODE



Anti-cold function (prevents cold air blowing)



Normal operation

BI-DIRECTIONAL AIRFLOW, 4-WAY AIR INTAKE

Comfortable temperature conditions in the room. Thanks to various possibilities of air supply settings there can be achieved several varieties of air circulation.



Air outlet



Air inlet

FUNCTIONS

STANDARD

OPTIONAL



Wireless remote control



Anti-cold Air Function



Self-diagnosis and safety



Refrigerant leakage detect



Auto swing



Bi-directional airflow



Emergency operation



Low Ambient Cooling



Wired controller



Multifunctional filter



Silver ion filter



Sleep mode



Timer



Auto restart



Turbo mode



Follow Me

TECHNICAL DATA

Indoor unit			MFAU-12HRFN1-QRDAW		
Outdoor unit			MOBA-12HFN1-QRDAW		
Indoor unit power supply (V/phase/Hz)			220-240/1/50		
Outdoor unit power supply (V/phase/Hz)			220-240/1/50		
Cooling	Capacity	Nominal	kW	3.5	
		Min-Max	kW	0.62~4.40	
	Rated input power		kW	1.03	
	EER		kW/kW	3.41	
	Design capacity		kW	3.5	
	Annual energy consumption		kWh/a	184	
	SEER			6.1	
ErP energy efficiency class			A++		
Heating	Capacity	Nominal	kW	3.8	
		Min-Max	kW	0.62~4.95	
	Rated input power		kW	1.00	
	COP		kW/kW	3.81	
	Design capacity		kW	3.6	
	Annual energy consumption		kWh/a	1225	
	SCOP			4.0	
ErP energy efficiency class			A+		
Maximum current input			A	8.7	
Indoor unit	Dimensions (W x D x H)		mm	700x600x210	
	Shipping dimensions (W x D x H)		mm	810x710x305	
	Net/Gross weight		kg	15/20	
	Airflow rate (low/medium/high)		m ³ /min	6.0/7.8/9.2	
	Sound pressure level (low/medium/high)		dB(A)	35/41/47	
	Sound power level		dB(A)	58	
Outdoor unit	Dimensions (W x D x H)		mm	800x333x554	
	Shipping dimensions (W x D x H)		mm	920x390x615	
	Net/Gross weight		kg	34.5/37.3	
	Airflow rate		m ³ /min	33.3	
	Sound pressure level		dB(A)	57	
	Sound power level		dB(A)	60	
Refrigerant	Type			R410A	
	Charge		kg	1.38	
Piping	Liquid/Gas		mm	Ø6.35 / Ø9.52	
	Maximum length		m	35	
	Maximum height difference		m	10	
Drain pipe diameter			mm	Ø16	
Recommended electric wiring and safety devices	Indoor unit power supply cable		mm ²	3x1.5	
	Outdoor unit power supply cable		mm ²	3x1.5	
	Communication cable		mm ²	2x0.75 (screened)	
	Fuse		A	16	
Outdoor unit operation temperature range			Cooling	°C	-15 ~ 50
			Heating	°C	-15 ~ 24

The capacity is based on the following conditions:

Cooling: indoor temperature 27°C DB/19°C WB; outdoor temperature 35°C DB/24°C WB

Heating: indoor temperature 20°C DB/15°C WB; outdoor temperature 7°C DB/6°C WB

Piping length: Connected pipes length 7.5 m, height difference 0.

Ceiling & Floor



TWO WAYS OF INSTALLATION

The unit structural design allows it to be installed in two positions: horizontally under the ceiling or vertically on the floor. This significantly increases the range of unit possible applications.

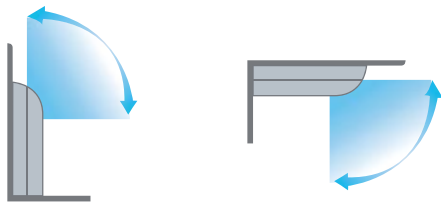

Suitable for vertical installation against a wall or horizontal under ceiling

ON/OFF AND ALARM PORTS

On the indoor unit control board there are available optional ports for remote turning on of the air-conditioner as well as alarm signalling. This solution is mainly intended for units operating in service rooms.

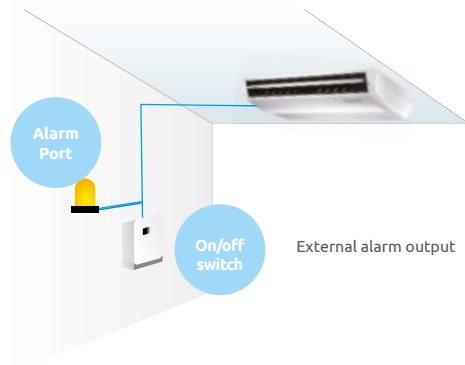

TURBO

This function sets the fan to operate with the highest speed in order to cool down or heat up the room in a short time.



FRESH AIR SUPPLY

Fresh air can be provided to the room in order to ensure high air quality inside the air-conditioned room.



FUNCTIONS

STANDARD

OPTIONAL



Wireless remote control



Sleep mode



3D blow



Refrigerant leakage detect



Louver position memory



Emergency operation



Fresh air



Central controller



Follow Me



8°C heating



Wired controller



Alarm port



Anti-cold Air Function



Optional condensate drain connection



Timer



Built-in drain pump



Low Ambient Cooling

TECHNICAL DATA

Indoor unit			MUE-18HRFN1-QRDA	MUE-24HRFN1-QRDA	MUE-30HRFN1-QRDA	MUE-36HRFN1-QRDA	MUE-36HRFN1-QRDA	MUE-48HRFN1-QRDA	MUE-48HRFN1-QRDA	MUE-55HRFN1-QRDA		
Outdoor unit			MOBA-18HFN1-QRDA	MOCA-24HFN1-QRDA	MODA-30HFN1-QRDA	MODA-36HFN1-QRDA	MODA-36HFN1-RRDA	MOEA-48HFN1-QRDA	MOEA-48HFN1-RRDA	MOEA-55HFN1-RRDA		
Indoor unit power supply (V/phase/Hz)			220-240/1/50									
Outdoor unit power supply (V/phase/Hz)			220-240/1/50			380-415/3/50		220-240/1/50		380-415/3/50		
Cooling	Capacity	Nominal	kW	5.3	7.0	8.8	10.6	10.6	14.1	14.1	15.8	
		Min-Max	kW	0.8~6.2	1.2~8.2	2.1~10.6	2.9~12.0	2.9~12.0	4.1~16.4	4.1~16.4	5.0~18.1	
	Rated input power		kW	1.63	2.29	2.96	4.06	4.06	5.19	5.19	6.06	
	EER		kW/kW	3.25	3.06	2.97	2.61	2.61	2.72	2.72	2.61	
	Design capacity		kW	5.3	7.1	8.8	10.5	10.5	14.0	14.0	16.0	
	Annual energy consumption		kWh/a	262	396	468	570	570	817	817	920	
	SEER			6.5	6.1	6.1	6.3	6.3	6.1	6.1	6.1	
ErP energy efficiency class			A++	A++	A++	A++	A++	A++	A++	A++		
Heating	Capacity	Nominal	kW	5.6	7.0	9.4	11.1	11.1	16.4	16.4	18.2	
		Min-Max	kW	0.9~7.0	1.2~8.6	2.1~10.8	2.6~13.2	2.6~13.2	4.4~18.5	4.4~18.5	5.3~20.5	
	Rated input power		kW	1.46	1.90	2.48	2.99	2.99	4.81	4.81	5.65	
	COP		kW/kW	3.84	3.68	3.80	3.72	3.72	3.41	3.41	3.22	
	Design capacity		kW	4.9	5.8	8.2	10.5	10.5	11.8	11.8	12.0	
	Annual energy consumption		kWh/a	1748	2114	2883	3633	3633	3942	3942	3970	
	SCOP			4.0	4.0	4.0	4.0	4.0	4.0	4.0	4.0	
ErP energy efficiency class			A+	A+	A+	A+	A+	A+	A+	A+		
Maximum current input		A	10.0	14.0	19.0	21.0	10.0	26.5	13.0	14.0		
Indoor unit	Dimensions (W x D x H)		mm	1068x675x235	1068x675x235	1285x675x235	1650x675x235	1650x675x235	1650x675x235	1650x675x235	1650x675x235	
	Shipping dimensions (W x D x H)		mm	1145x755x313	1145x755x313	1360x755x313	1725x755x313	1725x755x313	1725x755x313	1725x755x313	1725x755x313	
	Net/Gross weight		kg	25.8/30.6	25.0/30.0	31.0/36.5	40.3/46.9	40.3/46.9	38.2/44.6	38.2/44.6	40.5/47.0	
	Airflow rate (low/medium/high)		m ³ /min	11.7/13.3/15.0	14.2/17.5/19.7	20.8/24.2/27.5	23.4/29.5/34.1	23.4/29.5/34.1	23.3/30.0/35.0	23.3/30.0/35.0	21.3/27.7/37.5	
	Sound pressure level (low/medium/high)		dB(A)	34/39/44	42/48/53	44/49/54	40/46/52	40/46/52	41/46/52	41/46/52	45/50/55	
	Sound power level		dB(A)	65	65	66	66	66	72	72	70	
Outdoor unit	Dimensions (W x D x H)		mm	800x333x554	854x363x702	946x410x810	946x410x810	946x410x810	952x410x1333	952x410x1333	952x410x1333	
	Shipping dimensions (W x D x H)		mm	920x390x615	965x395x755	1090x500x865	1090x500x865	1090x500x865	1095x500x1470	1095x500x1470	1095x500x1470	
	Net/Gross weight		kg	35.5/38.4	49.0/51.5	62.9/68.5	67.2/72.9	78.9/83.9	95.1/108.4	108.1/121.2	112.8/126.0	
	Airflow rate		m ³ /min	35.0	45.0	71.7	71.7	71.7	113.3	113.3	120.0	
	Sound pressure level		dB(A)	56.5	60.5	59.5	62.0	62.0	65.0	65.0	62.5	
	Sound power level		dB(A)	64	65	66	67	67	72	72	75	
Refrigerant	Type			R410A	R410A	R410A	R410A	R410A	R410A	R410A	R410A	
	Charge		kg	1.48	1.95	2.80	3.20	3.20	4.00	4.00	4.30	
Piping	Liquid/Gas		mm	Ø6.35 / Ø12.7	Ø9.52 / Ø15.9	Ø9.52 / Ø15.9	Ø9.52 / Ø15.9	Ø9.52 / Ø15.9	Ø9.52 / Ø15.9	Ø9.52 / Ø15.9	Ø9.52 / Ø15.9	
	Maximum length		m	30	50	50	65	65	65	65	65	
	Maximum height difference		m	20	25	25	30	30	30	30	30	
Drain pipe diameter		mm	Ø25	Ø25	Ø25	Ø25	Ø25	Ø25	Ø25	Ø25		
Recommended electric wiring and safety devices	Indoor unit power supply cable		mm ²	3x1.5	3x1.5	3x1.5	3x1.5	3x1.5	3x1.5	3x1.5	3x1.5	
	Outdoor unit power supply cable		mm ²	3x1.5	3x2.5	3x2.5	3x4.0	5x2.5	3x4.0	5x2.5	5x2.5	
	Communication cable		mm ²	2x0.75 (screened)								
	Fuse		A	16	20	20	25	20	30	25	25	
Outdoor unit operation temperature range		Cooling	°C	-15 ~ 50								
		Heating	°C	-15 ~ 24								

The capacity is based on the following conditions:

Cooling: indoor temperature 27°C DB/19°C WB; outdoor temperature 35°C DB/24°C WB

Heating: indoor temperature 20°C DB/15°C WB; outdoor temperature 7°C DB/6°C WB

Piping length: Connected pipes length 7.5 m, height difference 0.

Cassette units



ADDITIONAL AIR SUPPLY DUCT

The pre-cut holes in the cover enable connecting the fresh air supplying duct and also allow for installation of ducts supplying additional air inlets with cooled down air from the air-conditioner.

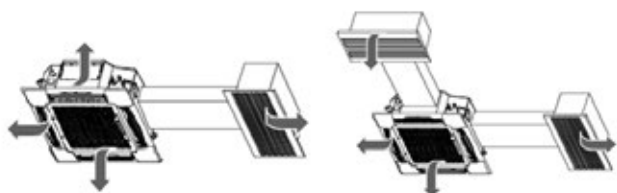

SUPER SLIM DESIGN

A specially designed internal unit has the height of only 205 mm (5.3 kW unit). This enables installing the air-conditioner in very narrow ceiling voids.

Super slim design

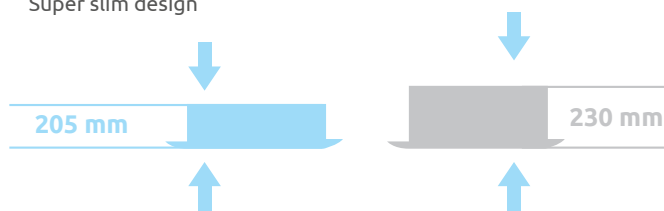

WIDE AIR OUTLET ANGLE

Louvers driven by two motors enable adjustment of air outlet angle in range of 40°. This enables to adapt the air direction to the individual user needs.

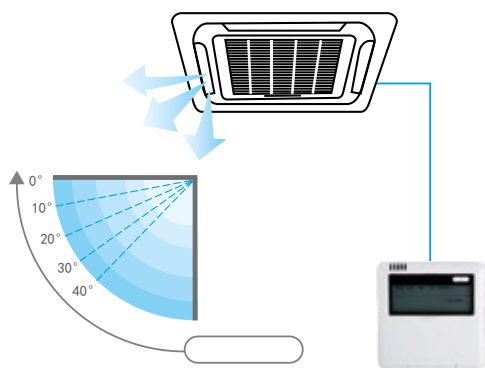

360° AIR FLOW PANEL

Air-conditioner panel with additional air nozzles at the corners ensure excellent air distribution across the entire room.



FUNCTIONS

STANDARD



Wireless remote control



Anti-cold Air Function



Alarm port



Refrigerant leakage detect



Fresh air



Louver position memory



Built-in drain pump



Central controller



Follow Me



Wired controller



8°C heating



360° airflow



Temperature compensation



Low Ambient Cooling



Emergency operation

OPTIONAL

TECHNICAL DATA

Indoor unit				MCD-18HRFN1-QRDA	MCD-24HRFN1-QRDA	MCD-30HRFN1-QRDA	MCD-36HRFN1-QRDA	MCD-36HRFN1-QRDA	MCD-48HRFN1-QRDA	MCD-48HRFN1-QRDA	MCD-55HRFN1-QRDA	
Outdoor unit				MOBA-18HFN1-QRDA	MOCA-24HFN1-QRDA	MODA-30HFN1-QRDA	MODA-36HFN1-QRDA	MODA-36HFN1-RRDA	MOEA-48HFN1-QRDA	MOEA-48HFN1-RRDA	MOEA-55HFN1-RRDA	
Indoor unit power supply (V/phase/Hz)				220-240/1/50								
Outdoor unit power supply (V/phase/Hz)				220-240/1/50				380-415/3/50		220-240/1/50		380-415/3/50
Cooling	Capacity	Nominal	kW	5.3	7.0	8.8	10.6	10.6	13.8	13.8	16.1	
		Min-Max	kW	0.8~6.2	1.2~8.2	2.1~10.6	2.9~12.0	2.9~12.0	4.0~16.5	4.0~16.5	5.0~18.5	
	Rated input power		kW	1.69	2.17	2.77	4.06	4.06	5.30	5.30	6.40	
	EER		kW/kW	3.15	3.23	3.18	2.61	2.61	2.60	2.60	2.52	
	Design capacity		kW	5.3	7.0	8.8	10.5	10.5	14.0	14.0	16.0	
	Annual energy consumption		kWh/a	300	391	453	600	600	832	832	931	
	SEER			6.3	6.1	6.1	6.1	6.1	5.6	5.6	5.6	
ErP energy efficiency class			A++	A++	A++	A++	A++	A+	A+	A+		
Heating	Capacity	Nominal	kW	5.6	7.0	9.1	11.1	11.1	16.1	16.1	18.2	
		Min-Max	kW	0.9~7.0	1.2~8.7	2.1~10.5	2.6~13.2	2.6~13.2	4.2~19.0	4.2~19.0	5.3~20.5	
	Rated input power		kW	1.46	1.90	2.38	3.09	3.09	4.99	4.99	5.74	
	COP		kW/kW	3.84	3.68	3.82	3.60	3.60	3.23	3.23	3.17	
	Design capacity		kW	4.9	5.8	7.9	10.1	10.1	11.5	11.5	11.5	
	Annual energy consumption		kWh/a	1681	2154	2874	3562	3562	3960	3960	3945	
	SCOP			4.0	4.0	4.0	4.0	4.0	4.0	4.0	4.0	
ErP energy efficiency class			A+	A+	A+	A+	A+	A+	A+	A+		
Maximum current input			A	10.0	14.0	19.0	21.0	10.0	26.5	13.0	14.0	
Indoor unit	Dimensions (W x D x H)		mm	840x840x205	840x840x245	840x840x245	840x840x245	840x840x245	840x840x287	840x840x287	840x840x287	
	Shipping dimensions (W x D x H)		mm	900x900x217	900x900x257	900x900x257	900x900x257	900x900x257	900x900x292	900x900x292	900x900x292	
	Net/Gross weight		kg	21.3/25.0	24.0/28.0	26.5/30.5	25.6/29.9	25.6/29.9	28.0/32.1	28.0/32.1	31.0/34.0	
	Airflow rate (low/medium/high)		m³/min	11.7/13.3/16.7	18.3/20.8/24.2	21.7/24.3/28.3	24.3/29.2/31.7	24.3/29.2/31.7	23.3/26.7/30.8	23.3/26.7/30.8	24.2/27.5/31.7	
Indoor unit	Sound pressure level (low/medium/high)		dB(A)	37/41/46	39/42/46	44/48/53	47/50/53	47/50/53	48/51/55	48/51/55	46/49/52	
	Sound power level		dB(A)	56	61	64	61	61	63	63	68	
	Dimensions (W x D x H)		mm	800x333x554	854x363x702	946x410x810	946x410x810	946x410x810	952x410x1333	952x410x1333	952x410x1333	
Outdoor unit	Shipping dimensions (W x D x H)		mm	920x390x615	965x395x755	1090x500x865	1090x500x865	1090x500x865	1095x500x1470	1095x500x1470	1095x500x1470	
	Net/Gross weight		kg	35.5/38.4	49.0/51.5	62.9/68.5	67.2/72.9	78.9/83.9	95.1/108.4	108.1/121.2	112.8/126.0	
	Airflow rate		m³/min	35.0	45.0	71.7	71.7	71.7	113.3	113.3	120.0	
	Sound pressure level		dB(A)	56.5	60.5	59.5	62.0	62.0	65.0	65.0	62.5	
	Sound power level		dB(A)	64	65	66	67	67	72	72	75	
Panel	Symbol			T-MBQ-02C1								
	Dimensions (W x D x H)		mm	950x950x55	950x950x55	950x950x55	950x950x55	950x950x55	950x950x55	950x950x55	950x950x55	
	Shipping dimensions (W x D x H)		mm	1035x1035x90	1035x1035x90	1035x1035x90	1035x1035x90	1035x1035x90	1035x1035x90	1035x1035x90	1035x1035x90	
	Net/Gross weight		kg	5/8	5/8	5/8	5/8	5/8	5/8	5/8	5/8	
Refrigerant	Type			R410A	R410A	R410A	R410A	R410A	R410A	R410A	R410A	
	Charge		kg	1.48	1.95	2.80	3.20	3.20	4.00	4.00	4.30	
Piping	Liquid/Gas		mm	Ø6.35 / Ø12.7	Ø9.52 / Ø15.9	Ø9.52 / Ø15.9	Ø9.52 / Ø15.9	Ø9.52 / Ø15.9	Ø9.52 / Ø15.9	Ø9.52 / Ø15.9	Ø9.52 / Ø15.9	
	Maximum length		m	30	50	50	65	65	65	65	65	
	Maximum height difference		m	20	25	25	30	30	30	30	30	
Drain pipe diameter			mm	Ø32	Ø32	Ø32	Ø32	Ø32	Ø32	Ø32	Ø32	
Recommended electric wiring and safety devices	Indoor unit power supply cable		mm²	3x1.5	3x1.5	3x1.5	3x1.5	3x1.5	3x1.5	3x1.5	3x1.5	
	Outdoor unit power supply cable		mm²	3x1.5	3x2.5	3x2.5	3x4.0	5x2.5	3x4.0	5x2.5	5x2.5	
	Communication cable		mm²	2x0.75 (screened)								
	Fuse		A	16	20	20	25	20	30	25	25	
Outdoor unit operation temperature range			Cooling	°C -15 ~ 50								
			Heating	°C -15 ~ 24								

The capacity is based on the following conditions:

Cooling: indoor temperature 27°C DB/19°C WB; outdoor temperature 35°C DB/24°C WB

Heating: indoor temperature 20°C DB/15°C WB; outdoor temperature 7°C DB/6°C WB

Piping length: Connected pipes length 7.5 m, height difference 0.

Compact cassette units



BUILT-IN CONDENSATE PUMP

The built-in condensate pump with the pump head of up to 750 mm makes it easier to distribute the condensate draining installation in the space above the suspended ceiling.

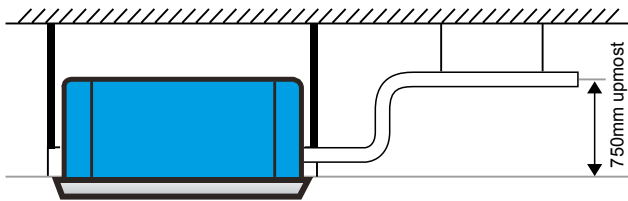

WIRED CONTROLLER

Compared to wireless controllers, the wired controller can be fixed permanently to a wall which makes it impossible to lose it.



LOW AMBIENT COOLING

The MDV air conditioners have been designed in such a way as to enable their operation in the cooling mode even when the temperature falls down to -15°C .

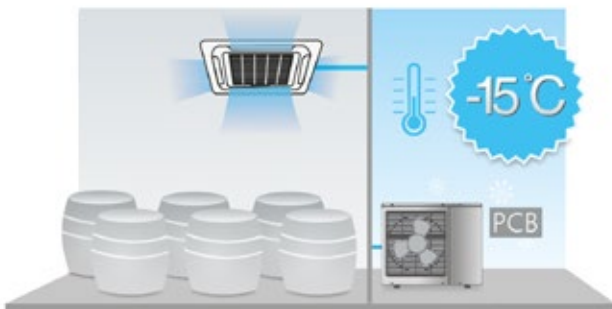

ON/OFF AND ALARM PORTS

On the indoor unit control board there are available optional ports for remote turning on of the air-conditioner as well as alarm signalling. This solution is mainly intended for units operating in service rooms.

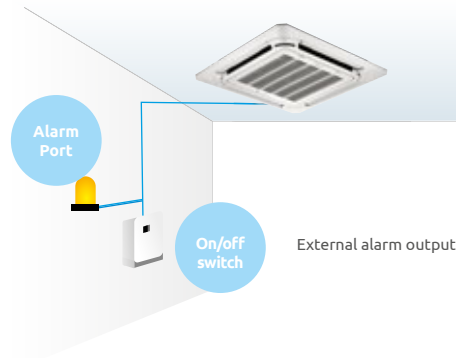

FUNCTIONS

STANDARD

OPTIONAL



Wireless remote control



Anti-cold Air Function



Alarm port



Refrigerant leakage detect



Fresh air



Louver position memory



Built-in condensate pump



Central controller



Follow Me



Wired controller



8°C heating



Auto restart



Temperature compensation



Low Ambient Cooling



Emergency operation

TECHNICAL DATA

Indoor unit				MCA3U-12HRFN1-QRDAW	MCA3-18HRFN1-QRDA
Outdoor unit				MOBA-12HFN1-QRDAW	MOBA-18HFN1-QRDA
Indoor unit power supply (V/phase/Hz)				220-240/1/50	
Outdoor unit power supply (V/phase/Hz)				220-240/1/50	
Cooling	Capacity	Nominal	kW	3.5	5.3
		Min-Max	kW	0.6~4.4	0.8~6.2
	Rated input power		kW	0.96	1.63
	EER		kW/kW	3.65	3.25
	Design capacity		kW	3.5	5.3
	Annual energy consumption		kWh/a	183	278
	SEER			6.1	6.3
ErP energy efficiency class			A++	A++	
Heating	Capacity	Nominal	kW	4.1	5.6
		Min-Max	kW	0.6~5.13	0.9~7.0
	Rated input power		kW	1.00	1.50
	COP		kW/kW	4.12	3.73
	Design capacity		kW	3.6	4.8
	Annual energy consumption		kWh/a	1141	1626
	SCOP			4.0	4.0
ErP energy efficiency class			A+	A+	
Maximum current input			A	8.7	10.0
Indoor unit	Dimensions (W x D x H)		mm	570x570x260	570x570x260
	Net/Gross weight		kg	16.0/19.0	16.5/19.0
	Airflow rate (low/medium/high)		m ³ /min	7.5/8.8/10.8	8.2/9.2/11.0
	Sound pressure level (low/medium/high)		dB(A)	34/38/42	38/42/46
	Sound power level		dB(A)	57	56
Outdoor unit	Dimensions (W x D x H)		mm	800x333x554	800x333x554
	Net/Gross weight		kg	34.5/37.3	35.5/38.4
	Airflow rate		m ³ /min	33.3	35.0
	Sound pressure level		dB(A)	57.0	56.5
	Sound power level		dB(A)	60	64
Panel	Symbol			T-MBQ4-03E	T-MBQ4-03E
	Dimensions (W x D x H)		mm	647x647x50	647x647x50
	Shipping dimensions (W x D x H)		mm	715x715x123	715x715x123
	Net/Gross weight		kg	2.5/4.5	2.5/4.5
Refrigerant	Type			R410A	R410A
	Charge		kg	1.38	1.48
Piping	Liquid/Gas		mm	Ø6.35 / Ø9.52	Ø6.35 / Ø12.7
	Maximum length		m	35	30
	Maximum height difference		m	10	20
Drain pipe diameter			mm	Ø25	Ø25
Recommended electric wiring and safety devices	Indoor unit power supply cable		mm ²	3x1.5	3x1.5
	Outdoor unit power supply cable		mm ²	3x1.5	3x1.5
	Communication cable		mm ²	2x0.75 (screened)	
	Fuse		A	16	16
Outdoor unit operation temperature range			Cooling	°C -15 ~ 50	
			Heating	°C -15 ~ 24	

The capacity is based on the following conditions:

Cooling: indoor temperature 27°C DB/19°C WB; outdoor temperature 35°C DB/24°C WB

Heating: indoor temperature 20°C DB/15°C WB; outdoor temperature 7°C DB/6°C WB

Piping length: Connected pipes length 7.5 m, height difference 0.

Duct units



UNIVERSAL DUCT INSTALLATION

Two air intake directions – on the rear and from the bottom. The air inlet can be easily changed by the installer during assembly.

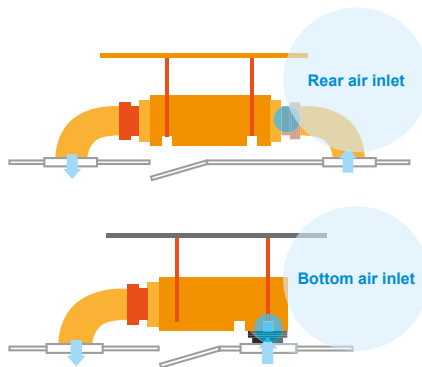

FRESH AIR SUPPLY

Fresh air can be provided to the room in order to ensure high air quality inside the air-conditioned room.



LOW AMBIENT COOLING

Thanks to the built-in, additional low ambient kit and specially designed PCB control board, the air-conditioner can operate in cooling mode even if the outdoor temperature falls to -15°C .



WIRED CONTROLLER

Compared to wireless controllers, the wired controller can be fixed permanently to a wall which makes it impossible to lose it.



FUNCTIONS

STANDARD

OPTIONAL



Adjustable Static Pressure Switch



Alarm port



Temperature compensation



Refrigerant leakage detect



Louver position memory



Fresh air



Low Ambient Cooling



Wired controller



Follow Me



Anti-cold Air Function



Optional condensate drain connection



Timer



Built-in drain pump



Emergency operation



Central controller

TECHNICAL DATA

Indoor unit			MTBU-12HWFN1-QRDAW	MTB-18HWFN1-QRDA	MTB-24HWFN1-QRDA	MTB-30HWFN1-QRDA	MTB-36HWFN1-QRDA	MTB-36HWFN1-RRDA	MTB-48HWFN1-QRDA	MTB-48HWFN1-RRDA	MTB-55HWFN1-RRDA	
Outdoor unit			MOBA-12HFN1-QRDAW	MOBA-18HFN1-QRDA	MOCA-24HFN1-QRDA	MODA-30HFN1-QRDA	MODA-36HFN1-QRDA	MODA-36HFN1-RRDA	MOEA-48HFN1-QRDA	MOEA-48HFN1-RRDA	MOEA-55HFN1-RRDA	
Indoor unit power supply (V/phase/Hz)			220-240/1/50									
Outdoor unit power supply (V/phase/Hz)			220-240/1/50				380-415/3/50		220-240/1/50		380-415/3/50	
Cooling	Capacity	Nominal	kW	3.5	5.3	7.0	8.8	10.6	10.6	14.1	14.1	15.8
		Min-Max	kW	0.6~4.4	0.8~6.2	1.2~8.2	2.1~10.6	2.9~12.0	2.9~12.0	4.1~16.4	4.1~16.4	5.0~18.1
	Rated input power	kW	1.03	1.69	2.29	2.88	3.97	3.97	5.12	5.12	5.26	
	EER	kW/kW	3.40	3.15	3.06	3.06	2.67	2.67	2.67	2.76	2.76	3.01
	Design capacity	kW	3.5	5.3	7.0	8.8	10.5	10.5	14.0	14.0	16.0	
	Annual energy consumption	kWh/a	192	282	381	453	581	581	812	812	870	
	SEER		6.1	6.5	6.1	6.1	6.3	6.3	6.1	6.1	6.1	
ErP energy efficiency class			A++	A++	A++	A++	A++	A++	A++	A++	A++	
Heating	Capacity	Nominal	kW	3.8	5.6	7.0	9.4	11.1	11.1	16.1	16.1	18.2
		Min-Max	kW	0.6~5.0	0.9~7.0	1.2~8.7	2.1~10.9	2.6~13.2	2.6~13.2	4.3~18.1	4.3~18.1	5.3~20.5
	Rated input power	kW	1.00	1.46	1.90	2.46	2.92	2.92	4.36	4.36	5.03	
	COP	kW/kW	3.82	3.84	3.68	3.82	3.80	3.80	3.70	3.70	3.62	
	Design capacity	kW	3.3	4.7	5.8	8.2	10.5	10.5	12.2	12.2	12.3	
	Annual energy consumption	kWh/a	1183	1653	2104	2874	3658	3658	4214	4214	4035	
	SCOP		4.0	4.0	4.0	4.0	4.0	4.0	4.0	4.0	4.0	
ErP energy efficiency class			A+	A+	A+	A+	A+	A+	A+	A+		
Maximum current input			A	8.7	10.0	14.0	19.0	21.0	10.0	26.5	13.0	14.0
Indoor unit	Dimensions (W x D x H)		mm	700x635x210	920x635x270	920x635x270	1140x775x270	1200x865x300	1200x865x300	1200x865x270	1200x865x270	1200x865x270
	Shipping dimensions (W x D x H)		mm	915x655x290	1150x655x350	1150x655x350	1355x795x350	1405x920x373	1405x920x373	1405x920x373	1405x920x373	1405x920x373
	Net/Gross weight		kg	18.4/22.7	26.9/31.5	28.0/31.5	35.0/42.0	45.0/53.0	45.0/53.0	43.2/51.6	43.2/51.6	43.1/51.5
	External static pressure (range)		Pa	0~45	0~100	0~100	0~100	0~100	0~100	0~100	0~100	0~100
	Airflow rate (low/medium/high)		m ³ /min	7.5/9.7/11.3	13.0/15.0/17.5	16.2/20.0/22.7	18.3/23.3/26.3	21.3/25.0/29.2	21.3/25.0/29.2	26.7/31.7/36.7	26.7/31.7/36.7	26.7/31.7/36.7
	Sound pressure level (low/medium/high)		dB(A)	35/38/42	37/40/44	38/42/46	44/48/50	40/45/48	40/45/48	44/47/50	44/47/50	45/47/50
	Sound power level		dB(A)	54	58	62	65	61	61	68	68	69
Outdoor unit	Dimensions (W x D x H)		mm	800x333x554	800x333x554	854x363x702	946x410x810	946x410x810	946x410x810	952x410x1333	952x410x1333	952x410x1333
	Shipping dimensions (W x D x H)		mm	920x390x615	920x390x615	965x395x755	1090x500x865	1090x500x865	1090x500x865	1095x500x1470	1095x500x1470	1095x500x1470
	Net/Gross weight		kg	34.5/37.3	35.5/38.4	49.0/51.5	62.9/68.5	67.2/72.9	78.9/83.9	95.1/108.4	108.1/121.2	112.8/126.0
	Airflow rate		m ³ /min	33.3	35.0	45.0	71.7	71.7	71.7	113.3	113.3	120.0
	Sound pressure level		dB(A)	57.0	56.5	60.5	59.5	62.0	62.0	65.0	65.0	62.5
	Sound power level		dB(A)	60	64	65	66	67	67	72	72	75
Refrigerant	Type			R410A	R410A	R410A	R410A	R410A	R410A	R410A	R410A	R410A
	Charge		kg	1.38	1.48	1.95	2.80	3.20	3.20	4.00	4.00	4.30
Piping	Liquid/Gas		mm	Ø6.35 / Ø9.52	Ø6.35 / Ø12.7	Ø9.52 / Ø15.9	Ø9.52 / Ø15.9	Ø9.52 / Ø15.9	Ø9.52 / Ø15.9	Ø9.52 / Ø15.9	Ø9.52 / Ø15.9	Ø9.52 / Ø15.9
	Maximum length		m	25	30	50	50	65	65	65	65	65
	Maximum height difference		m	10	20	25	25	30	30	30	30	30
Drain pipe diameter			mm	Ø25	Ø25	Ø25	Ø25	Ø25	Ø25	Ø25	Ø25	Ø25
Recommended electric wiring and safety devices	Indoor unit power supply cable		mm ²	3x1.5	3x1.5	3x1.5	3x1.5	3x1.5	3x1.5	3x1.5	3x1.5	3x1.5
	Outdoor unit power supply cable		mm ²	3x1.5	3x1.5	3x2.5	3x2.5	3x4.0	5x2.5	3x4.0	5x2.5	5x2.5
	Communication cable		mm ²	2x0.75 (screened)								
	Fuse		A	16	16	20	20	25	20	30	25	25
Outdoor unit operation temperature range			Cooling	°C				-15 ~ 50				
			Heating	°C				-15 ~ 24				

The capacity is based on the following conditions:

Cooling: indoor temperature 27°C DB/19°C WB; outdoor temperature 35°C DB/24°C WB

Heating: indoor temperature 20°C DB/15°C WB; outdoor temperature 7°C DB/6°C WB

Piping length: Connected pipes length 7.5 m, height difference 0.

Duct units BIG Inverter



HIGH STATIC PRESSURE

Static pressure up to 200 Pa enables use of ducts with length up to 14 m and at a height of up to 6,5 m. Unit dedicated to large, spacious rooms.

FLEXIBLE INSTALLATION

High static pressure allows to apply different solutions of air distribution in rooms with unusual shapes.

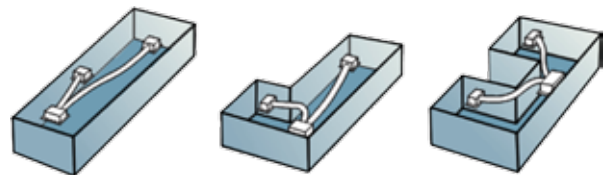
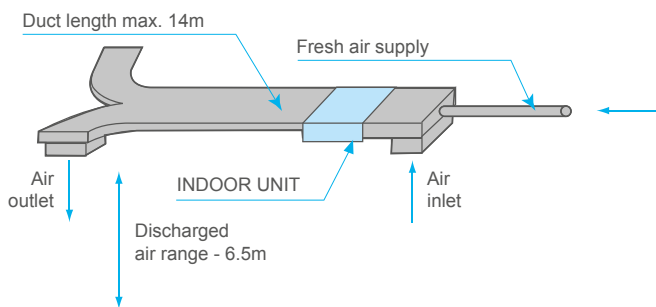

HIGH EFFICIENCY DC FAN MOTOR

The system controls the speed of the fan motor according to the system pressure and system load achieving the minimum power consumption. In comparison to AC motor fans, the electric energy consumption has been reduced by 50%. The additional advantage of DC motor fans is the lower level of noise emitted.

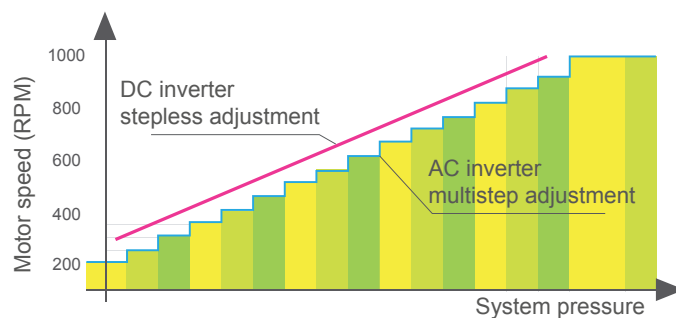

FUNCTIONS

STANDARD

OPTIONAL



Wireless remote control



Follow Me



Anti-cold Air Function



Refrigerant leakage detect



Fresh air



Low Ambient Cooling



Built-in drain pump



Timer



Follow Me



Wired controller



Auto restart



Wired controller



Central controller

TECHNICAL DATA

Indoor unit			MHC1-76HWD1N1	MHC-96HWD1N1(A)
Outdoor unit			MOVG1-76HD1N1-R	MOUA-96HD1N1-R
Indoor unit power supply (V/phase/Hz)			220-240/1/50	220-240/1/50
Outdoor unit power supply (V/phase/Hz)			380-415/3/50	380-415/3/50
Cooling	Rated capacity	kW	20.0	28.0
	Rated input power	kW	6.2	9.0
	EER	kW/kW	3.23	3.11
Heating	Rated capacity	kW	20.0	31.5
	Rated input power	kW	6.2	8.5
	COP	kW/kW	3.23	3.71
Indoor unit	Dimensions (W x D x H)	mm	1470x510x795	1470x512x775
	Shipping dimensions (W x D x H)	mm	1555x545x875	1555x545x875
	Net/Gross weight	kg	83/94	83/92
	External static pressure (range)	Pa	0~200	0~150
	Airflow rate (low/high)	m ³ /min	23/-	50/80
	Sound pressure level (low/high)	dB(A)	56/-	49/52
Outdoor unit	Dimensions (W x D x H)	mm	948x1585x968	1120x1558x528
	Shipping dimensions (W x D x H)	mm	1010x1705x1000	1270x1720x565
	Net/Gross weight	kg	231/242	147/163
	Airflow rate	m ³ /min	208.3	163.3
	Sound pressure level	dB(A)	66	59
Refrigerant	Type		R410A	R410A
	Charge	kg	9.0	7.2
Piping	Liquid/Gas	mm	Ø12.7 / Ø28.6	Ø9.53 / Ø25.4
	Maximum length	m	50	50
	Maximum height difference	m	30	30
Recommended electric wiring and safety devices	Indoor unit power supply cable	mm ²	3x2.5	3x2.5
	Outdoor unit power supply cable	mm ²	5x6.0	5x6.0
	Communication cable	mm ²	3x0.75 (screened)	3x0.75 (screened)
	Fuse	A	40	40
Outdoor unit operation temperature range	Cooling	°C	-15 ~ 48	-15 ~ 48
	Heating	°C	-15 ~ 24	-15 ~ 24

The capacity is based on the following conditions:

Cooling: indoor temperature 27°C DB/19°C WB; outdoor temperature 35°C DB/24°C WB

Heating: indoor temperature 20°C DB/15°C WB; outdoor temperature 7°C DB/6°C WB

Piping length: Connected pipes length 7.5 m, height difference 0.

Duct units BIG On/Off



EASY INSTALLATION

BIG series duct type air-conditioners are an excellent alternative to small air handling units with condensing unit. MDV units are ready for direct installation, completely wired and factory-filled with refrigerant. The installer only needs to lay insulated refrigerant pipes and communication wires.



LONG PIPING

High values of allowable installation length simplify unit location in convenient, well ventilated place.

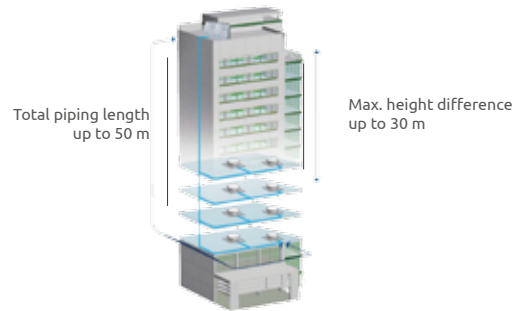

Allowable value		
Total piping length		50 m
Height difference	Outdoor unit above	25 m
	Outdoor unit below	30 m

HIGH CAPACITY, HIGH STATIC PRESSURE

BIG series duct units available static pressure is 196 Pa. This ensures adequate air distribution in ducts with a length of even up to 30 m.

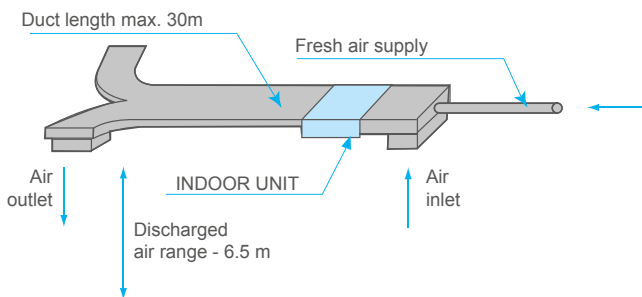

LOW AMBIENT COOLING

Thanks to the low ambient kit, the air-conditioner can operate in cooling mode even if the outdoor temperature falls to -20°C.

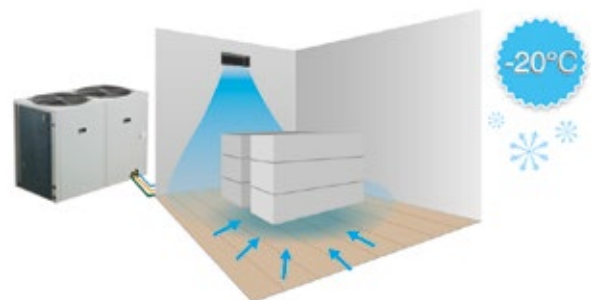

FUNCTIONS

STANDARD



Anti-cold Air Function



Refrigerant leakage detect



Fresh air



Low Ambient Cooling



Auto restart



Timer



Wired controller



Central controller

OPTIONAL

TECHNICAL DATA

Indoor unit			MHB-76HWN1	MHB-96HWN1	MTB-120HWN1	MHA-150HWN1	MHA-192HWN1
Outdoor unit			MOV-76HN1-R	MOV-96HN1-R	MOV-120HN1-R	MOV-150HN1-R	MOV-192HN1-R
Indoor unit power supply (V/phase/Hz)			220-240/1/50				
Outdoor unit power supply (V/phase/Hz)			380-415/3/50				
Cooling	Rated capacity	kW	22.3	28.1	35.0	44.0	56.3
	Rated input power	W	7500	9600	11900	16300	22000
	EER	W/W	2.97	2.93	2.94	2.70	2.56
Heating	Rated capacity	kW	25.0	31.1	38.0	47.0	58.6
	Rated input power	W	8300	10300	12700	15700	19300
	COP	W/W	3.01	3.02	2.99	2.99	3.04
Indoor unit	Indoor unit max. input power	W	1 300	1 400	2 000	2 730	4 690
	Indoor unit max. input current	A	5.2	5.8	9.0	12.1	20.9
	Airflow rate (low/medium/high)	m ³ /min	58/63/75	65/77/85	80/92/105	88/103/125	132/152/182
	Static pressure	Pa	196	196	100	196	196
	Sound pressure level (low/medium/high)	dB(A)	53/55/56	54/55/56	59/61/63	60/62/63	60/62/65
	Dimensions (W x H x D)	mm	1366×450×716	1366×450×716	1366×450×716	1828×668×858	1828×668×858
	Shipping dimensions (W x H x D)	mm	1555×500×875	1555×500×875	1555×500×875	2095×800×964	2095×800×964
	Net/gross weight	kg	94/106	96/108	97/109	188/200	235/250
Outdoor unit	Outdoor unit max. input power	W	11 700	14 400	17 300	26 900	32 200
	Outdoor unit max. input current	A	19.3	23.7	28.6	47.9	53.8
	Airflow rate	m ³ /min	125.0	158.5	200.0	250.0	317.0
	Sound pressure level	dB(A)	68	68	69	70	73
	Dimensions (W x H x D)	mm	1255×908×700	1255×908×700	1255×908×700	1250×1615×765	1390×1615×765
	Shipping dimensions (W x H x D)	mm	1320×1060×730	1320×1060×730	1320×1060×730	1305×1790×820	1455×1790×830
	Net/gross weight	kg	174/193	187/204	201/217	288/308	320/336
Drain pipe diameter	mm	Ø41	Ø41	Ø41	Ø41	Ø41	
Refrigerant	Type		R410A	R410A	R410A	R410A	R410A
	Charge	kg	5.4	5.5	7.5	10.0	11.8
Piping	Liquid/Gas	mm	Ø9.52/Ø22.00	Ø9.52/Ø25.00	Ø12.70/Ø28.60	Ø16.00/Ø32.00	Ø16.00/Ø32.00
	Maximum length	m	50				
	Max. height difference (outdoor unit above)	m	25				
	Max. height difference (outdoor unit below)	m	30				
Recommended electric wiring and safety devices	Indoor unit power supply cable	mm ²	3×2.5				
	Outdoor unit power supply cable	mm ²	5×6.0	5×10.0			5×15.0
	Communication cable	mm ²	4×1.0				
	Fuse	A	10/40	10/50	10/40	16/50	20/50
Outdoor unit operation temperature range	Cooling	°C	-7 ~ 43	-7 ~ 43	-7 ~ 43	-7 ~ 43	-7 ~ 43
	Heating	°C	-7 ~ 24	-7 ~ 24	-7 ~ 24	-7 ~ 24	-7 ~ 24

The capacity is based on the following conditions:

Cooling: indoor temperature 27°C DB/19°C WB; outdoor temperature 35°C DB/24°C WB

Heating: indoor temperature 20°C DB/15°C WB; outdoor temperature 7°C DB/6°C WB

Piping length: Connected pipes length 7.5 m, height difference 0.



TECHNICAL DATA

Indoor unit				MOBA-12HFN1-QRDAW	MOBA-18HFN1-QRDA	MOCA-24HFN1-QRDA	MODA-30HFN1-QRDA	MODA-36HFN1-QRDA
Outdoor unit power supply (V/phase/Hz)				220-240/1/50	220-240/1/50	220-240/1/50	220-240/1/50	220-240/1/50
Cooling	Capacity	Nominal	kW	3.5	5.3	7.0	8.8	10.6
		Min-Max	kW	0.6~4.4	0.8~6.2	1.2~8.2	2.1~10.6	2.9~12.0
	Rated input power		kW	0.96	1.63	2.17	2.77	4.06
	EER		kW/kW	3.65	3.25	3.23	3.18	2.61
	Design capacity		kW	3.5	5.3	7.0	8.8	10.5
	SEER			6.1	6.3	6.1	6.1	6.1
ErP energy efficiency class			A++	A++	A++	A++	A++	
Heating	Capacity	Nominal	kW	4.1	5.6	7.0	9.1	11.1
		Min-Max	kW	0.6~5.13	0.9~7.0	1.2~8.7	2.1~10.5	2.6~13.2
	Rated input power		kW	1.00	1.50	1.90	2.38	3.09
	COP		kW/kW	4.12	3.73	3.68	3.82	3.60
	Design capacity		kW	3.6	4.8	5.8	7.9	9.9
	SCOP			4.0	4.0	4.0	4.0	4.0
ErP energy efficiency class			A+	A+	A+	A+	A+	
Maximum current input			A	8.7	10.0	14.0	19.0	21.0
Maximum input power			W	2000	2200	2950	3400	4500
Airflow rate			m ³ /min	33.3	35.0	45.0	71.7	71.7
Sound pressure level			dB(A)	57.0	56.5	60.5	59.5	61.0
Sound power level			dB(A)	60	64	65	66	66
Expansion component				capillary tube + EXV	capillary tube + EXV	capillary tube + EXV	capillary tube + EXV	capillary tube + EXV
Dimensions (W x D x H)			mm	800x333x554	800x333x554	845x363x702	946x410x810	946x410x810
Shipping dimensions (W x D x H)			mm	920x390x615	920x390x615	965x395x755	1090x500x865	1090x500x865
Net/Gross weight			kg	34.5/37.3	35.5/38.4	49.0/51.5	62.9/68.5	67.2/72.9
Refrigerant	Type			R410A	R410A	R410A	R410A	R410A
	Charge	kg		1.38	1.48	1.95	2.80	3.20
Piping	Liquid/Gas	mm		Ø6.35 / Ø9.52	Ø6.35 / Ø12.7	Ø9.52 / Ø15.9	Ø9.52 / Ø15.9	Ø9.52 / Ø15.9
	Maximum length	m		25	30	50	50	65
	Maximum height difference	m		10	20	25	25	30
Recommended electric wiring and safety devices	Power source cable	mm ²		3x1.5	3x1.5	3x2.5	3x2.5	3x4.0
	Communication cable	mm ²		2x0.75 (screened)	2x0.75 (screened)	2x0.75 (screened)	2x0.75 (screened)	2x0.75 (screened)
	Fuse	A		16	16	20	20	25
Outdoor unit operation temperature range	Cooling	°C		-15 ~ 50	-15 ~ 50	-15 ~ 50	-15 ~ 50	-15 ~ 50
	Heating	°C		-15 ~ 24	-15 ~ 24	-15 ~ 24	-15 ~ 24	-15 ~ 24

The capacity is based on the following conditions:

Cooling: indoor temperature 27°C DB/19°C WB; outdoor temperature 35°C DB/24°C WB

Heating: indoor temperature 20°C DB/15°C WB; outdoor temperature 7°C DB/6°C WB

Piping length: Connected pipes length 7.5 m, height difference 0.



TECHNICAL DATA

Indoor unit				MODA-36HFN1-RRDA	MOEA-48HFN1-QRDA	MOEA-48HFN1-RRDA	MOEA-55HFN1-RRDA
Outdoor unit power supply (V/phase/Hz)				380-415/3/50	220-240/1/50	380-415/3/50	380-415/3/50
Cooling	Capacity	Nominal	kW	10.6	14.1	14.1	15.8
		Min-Max	kW	2.9~12.0	4.1~16.4	4.1~16.4	5.0~18.1
	Rated input power		kW	4.06	5.12	5.12	5.26
	EER		kW/kW	2.61	2.76	2.76	3.00
	Design capacity		kW	10.5	14.0	14.0	16.0
	SEER			6.1	6.1	6.1	6.1
ErP energy efficiency class			A++	A++	A++	A++	
Heating	Capacity	Nominal	kW	11.1	16.1	16.1	18.2
		Min-Max	kW	2.6~13.2	4.3~18.1	4.3~18.1	5.3~20.5
	Rated input power		kW	3.09	4.36	4.36	5.03
	COP		kW/kW	3.60	3.70	3.70	3.62
	Design capacity		kW	10.1	12.2	12.2	12.3
	SCOP			4.0	4.0	4.0	4.0
ErP energy efficiency class			A+	A+	A+	A+	
Maximum current input			A	10.0	26.5	13.0	14.0
Maximum input power			W	5300	6100	6100	7500
Airflow rate			m ³ /min	71.7	113.3	113.3	120.0
Sound pressure level			dB(A)	62.0	65.0	65.0	62.5
Sound power level			dB(A)	67	72	72	75
Expansion component				capillary tube + EXV	capillary tube + EXV	capillary tube + EXV	capillary tube + EXV
Dimensions (W x D x H)			mm	946x410x810	952x410x1333	952x410x1333	952x410x1333
Shipping dimensions (W x D x H)			mm	1090x500x865	1095x500x1470	1095x500x1470	1095x500x1470
Net/Gross weight			kg	78.9/83.9	95.1/108.4	108.1/121.2	112.8/126.0
Refrigerant	Type			R410A	R410A	R410A	R410A
	Charge	kg		3.20	4.00	4.00	4.30
Piping	Liquid/Gas	mm		Ø9.52 / Ø15.9	Ø9.52 / Ø15.9	Ø9.52 / Ø15.9	Ø9.52 / Ø15.9
	Maximum length	m		65	65	65	65
	Maximum height difference	m		30	30	30	30
Recommended electric wiring and safety devices	Power source cable	mm ²		5x2.5	3x4.0	5x2.5	5x2.5
	Communication cable	mm ²		2x0.75 (screened)	2x0.75 (screened)	2x0.75 (screened)	2x0.75 (screened)
	Fuse	A		20	30	25	25
Outdoor unit operation temperature range	Cooling	°C		-15 ~ 50	-15 ~ 50	-15 ~ 50	-15 ~ 50
	Heating	°C		-15 ~ 24	-15 ~ 24	-15 ~ 24	-15 ~ 24

The capacity is based on the following conditions:

Cooling: indoor temperature 27°C DB/19°C WB; outdoor temperature 35°C DB/24°C WB

Heating: indoor temperature 20°C DB/15°C WB; outdoor temperature 7°C DB/6°C WB

Piping length: Connected pipes length 7.5 m, height difference 0.

The background is a solid purple color with several overlapping white geometric shapes. These shapes include rounded rectangles and lines that form a complex, abstract pattern. The shapes are layered, with some appearing in front of others, creating a sense of depth. The overall aesthetic is modern and technical.

AIR HANDLING **UNITS**

DEDICATED DEVICES

STANDARD

Solutions for air handling unit



AIR KIT

The AIR Kit control module enables connecting a universal inverter-based external unit to a heat exchanger in the air handling unit.

Basic characteristics:

- straightforward design and low cost
- complete control over the condensing unit
- control by means of a 0~10V analog signal
- heating mode, cooling mode
- soft start function
- handles all the MDV devices belonging to the Office Standard series
- error diagnosis
- defrost function
- anti-freeze Frost sensor (optional)
- control by means of a 0~25 k Ω signal
- control by means of on/off signal

VERY SIMPLE CONNECTION

The system uses the expansion components built-in the outdoor unit, so additional valves are unnecessary.

Unit control is performed by means of input signals:

- potential-free on-off signal to enable cooling operation
- potential-free on-off signal to enable heating operation
- 0-10 V DC signal for the variable adjustment of unit capacity
- 0-25 k Ω resistance signal for the variable adjustment of unit capacity

Output signals from the control module:

- potential-free on-off signal in case of alarm generation
- potential-free on-off signal during defrost operation of the outdoor unit heat exchanger.

HEATING MODE/COOLING MODE

The Airkit module may supply the air handling unit exchangers operating both as air coolers and as air heaters.

SOFT START

The inverter-based compressor with the "soft" start function limits the temporary overloads and voltage dips in a building's power supply network. The highly efficient inverter-based compressors achieve the nominal efficiency in a very short time, which has a direct impact on the cooling or heating time of the air-conditioned rooms. Smaller temperature fluctuations ensure immediate feeling of comfort.



Comparison of inverter startup with traditional startup

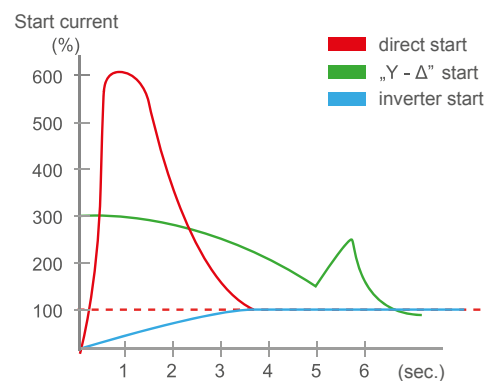

CONNECTION DIAGRAMS

Diagram of connection between the unit and the air handling unit that supplies air

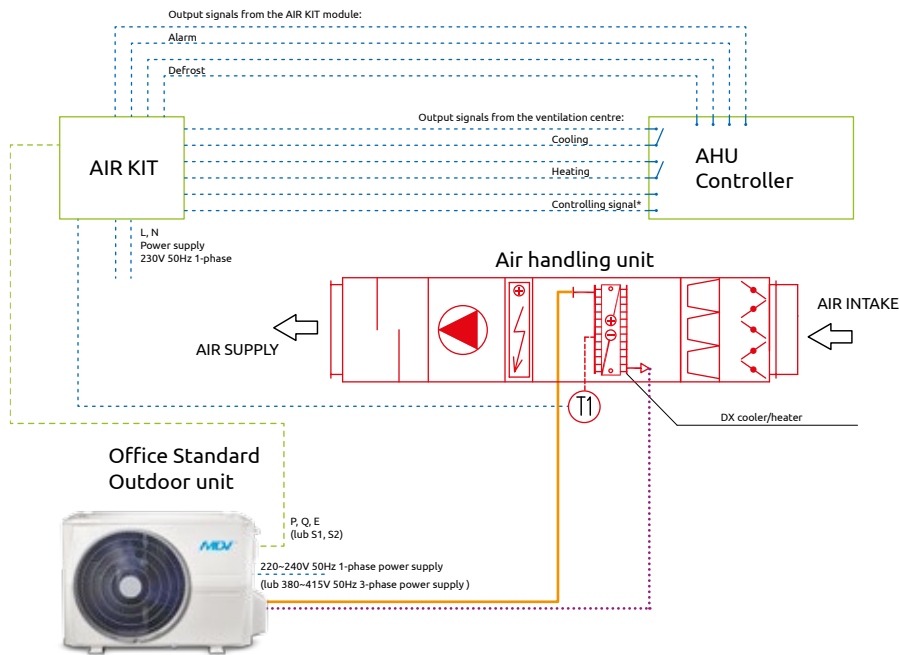

Designations:

- LIQUID copper pipeline, thermally insulated
- - - GAS copper pipeline, thermally insulated
- - - Electrical connections / Signal and control connections
- T1 Optional temperature sensor for anti-freeze protection

- *Control signals:
- analog 0~10V
 - resistance 0~25 Ω
 - ON/OFF

Diagram of connection between the unit and the air handling unit that supplies and discharges air

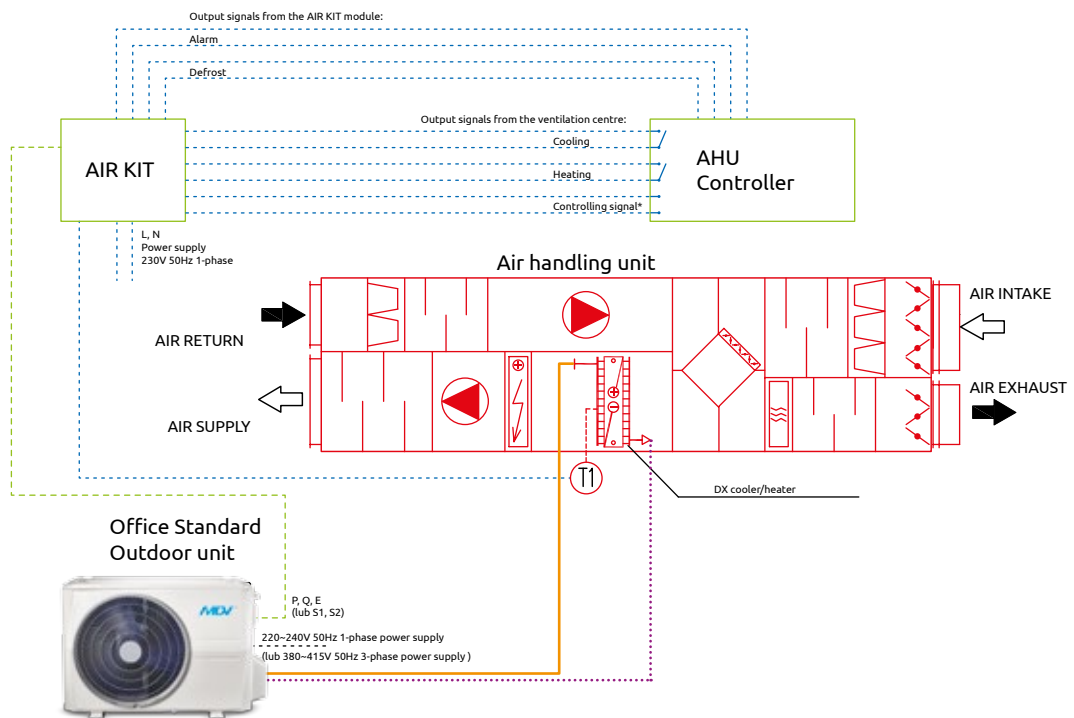

Designations:

- LIQUID copper pipeline, thermally insulated
- - - GAS copper pipeline, thermally insulated
- - - Electrical connections / Signal and control connections
- T1 Optional temperature sensor for anti-freeze protection

- *Control signals:
- analog 0~10V
 - resistance 0~25 Ω
 - ON/OFF

TECHNICAL DATA - INVERTER

Indoor unit			MOBA-18HFN1-QRDA	MOCA-24HFN1-QRDA	MODA-30HFN1-QRDA	MODA-36HFN1-QRDA	MODA-36HFN1-RRDA
Outdoor heat exchanger control module			AIR Kit	AIR Kit	AIR Kit	AIR Kit	AIR Kit
Outdoor unit power supply (V/phase/Hz)			220-240/1/50				380-415/3/50
Cooling	Capacity (min - max)	kW	0.8~6.2	1.2~8.2	2.1~10.6	2.9~12.0	2.9~12.0
	Rated input power	kW	1.63	2.17	2.77	4.06	4.06
	EER	kW/kW	3.25	3.23	3.18	2.61	2.61
Heating	Capacity (min - max)	kW	0.9~7.0	1.2~8.7	2.1~10.5	2.6~13.2	2.6~13.2
	Rated input power	kW	1.50	1.90	2.38	3.09	3.09
	COP	kW/kW	3.73	3.68	3.82	3.60	3.60
Maximum current input		A	10	14	19	21	10
Maximum input power		W	2200	2950	3400	4500	5300
Airflow rate		m ³ /min	35.0	45.0	71.7	71.7	71.7
Sound pressure level		dB(A)	56.5	60.5	59.5	61.0	62.0
Sound power level		dB(A)	64	65	66	66	67
Expansion component			capillary tube + EXV	capillary tube + EXV	capillary tube + EXV	capillary tube + EXV	capillary tube + EXV
Dimensions (W x D x H)		mm	800x333x554	845x363x702	946x410x810	946x410x810	946x410x810
Shipping dimensions (W x D x H)		mm	920x390x615	965x395x755	1090x500x865	1090x500x865	1090x500x865
Weight		kg	35.5	49.0	62.9	67.2	78.9
Refrigerant	Type		R410A	R410A	R410A	R410A	R410A
	Charge	kg	1.48	1.95	2.80	3.20	3.20
Piping	Liquid/Gas	mm	Ø6.35 / Ø12.7	Ø9.52 / Ø15.9	Ø9.52 / Ø15.9	Ø9.52 / Ø15.9	Ø9.52 / Ø15.9
	Maximum length	m	30	50	50	65	65
	Maximum height difference	m	20	25	25	30	30
Recommended electric wiring and safety devices	Power source cable	mm ²	3x1.5	3x2.5	3x2.5	3x4.0	5x2.5
	Communication cable	mm ²	2x0.75 (screened)				
	Fuse	A	16	20	20	25	20
Outdoor unit operation temperature range	Cooling	°C	-15 ~ 50	-15 ~ 50	-15 ~ 50	-15 ~ 50	-15 ~ 50
	Heating	°C	-15 ~ 24	-15 ~ 24	-15 ~ 24	-15 ~ 24	-15 ~ 24

The capacity is based on the following conditions:

Cooling: indoor temperature 27°C DB/19°C WB; outdoor temperature 35°C DB/24°C WB

Heating: indoor temperature 20°C DB/15°C WB; outdoor temperature 7°C DB/6°C WB

Piping length: Connected pipes length 7.5 m, height difference 0.

TECHNICAL DATA - INVERTER

			NEW			NEW		NEW	
Indoor unit			MOEA-48HFN1-QRDA	MOEA-48HFN1-RRDA	MOEA-55HFN1-RRDA	MOVG1-76HD1N1-R	MOUA-96HD1N1-R		
Outdoor heat exchanger control module			AIR Kit	AIR Kit	AIR Kit	AIR Kit	AIR Kit		
Outdoor unit power supply (V/phase/Hz)			220-240/1/50		380-415/3/50				
Cooling	Capacity (min - max)	kW	4.1~16.4	4.1~16.4	5.0~18.1	20.0	28.0		
	Rated input power	kW	5.12	5.12	5.26	6.20	9.00		
	EER	kW/kW	2.76	2.76	3.01	3.23	3.11		
Heating	Capacity (min - max)	kW	4.3~18.1	4.3~18.1	5.3~20.5	20.0	31.5		
	Rated input power	kW	4.36	4.36	5.03	6.20	8.50		
	COP	kW/kW	3.70	3.70	3.62	3.23	3.71		
Maximum current input		A	26.5	13.0	14.0	16.0	16.0		
Maximum input power		W	6100	6100	7500	8000	11700		
Airflow rate		m ³ /min	113.3	113.3	120.0	208.3	163.3		
Sound pressure level		dB(A)	65	65	62.5	66	59		
Sound power level		dB(A)	72	72	75	-	-		
Expansion component			capillary tube + EXV	capillary tube + EXV	capillary tube + EXV	EXV	EXV		
Dimensions (W x D x H)		mm	952x410x1333	952x410x1333	952x410x1333	948x968x1585	1120x1558x528		
Shipping dimensions (W x D x H)		mm	1095x500x1470	1095x500x1470	1095x500x1470	1010x1000x1705	1270x1720x565		
Weight		kg	95.1	108.1	112.8	231.0	147.0		
Refrigerant	Type		R410A	R410A	R410A	R410A	R410A		
	Charge	kg	4.00	4.00	4.30	9.00	7.20		
Piping	Liquid/Gas	mm	Ø9.52 / Ø15.9	Ø9.52 / Ø15.9	Ø9.52 / Ø15.9	Ø12.7 / Ø28.6	Ø9.53 / Ø25.4		
	Maximum length	m	65	65	65	50	50		
	Maximum height difference	m	30	30	30	30	30		
Recommended electric wiring and safety devices	Power source cable	mm ²	3x4.0	5x2.5	5x2.5	5x6.0	5x6.0		
	Communication cable	mm ²	2x0.75 (screened)						
	Fuse	A	30	25	25	25	25		
Outdoor unit operation temperature range	Cooling	°C	-15 ~ 50	-15 ~ 50	-15 ~ 50	-15 ~ 48	-15 ~ 48		
	Heating	°C	-15 ~ 24	-15 ~ 24	-15 ~ 24	-15 ~ 24	-15 ~ 24		

The capacity is based on the following conditions:

Cooling: indoor temperature 27°C DB/19°C WB; outdoor temperature 35°C DB/24°C WB

Heating: indoor temperature 20°C DB/15°C WB; outdoor temperature 7°C DB/6°C WB

Piping length: Connected pipes length 7.5 m, height difference 0.

Solutions for air handling units



MCCU UNIT

Outdoor units for supplying heat exchangers in air handling units. Universal outdoor units available volumes: 53 kW, 61 kW, 70 kW and 105 kW. Outdoor units operate only in cooling mode, achieving high energy efficiency ratios (EER). Universal outdoor units MCCU have two refrigerant circuits. This means that they can be connected to the air handling units with two-section heat exchanger.

EQUIPMENT

The unit is delivered together with a set of necessary for proper functioning thermostatic expansion valves, filters, sight glass and electromagnetic shut off valves. To control the unit it is necessary to lead the 230 V signal from air handling unit automation. R410A refrigerant.

OUTDOOR UNIT AND AIR HANDLING UNIT CONNECTION DIAGRAM

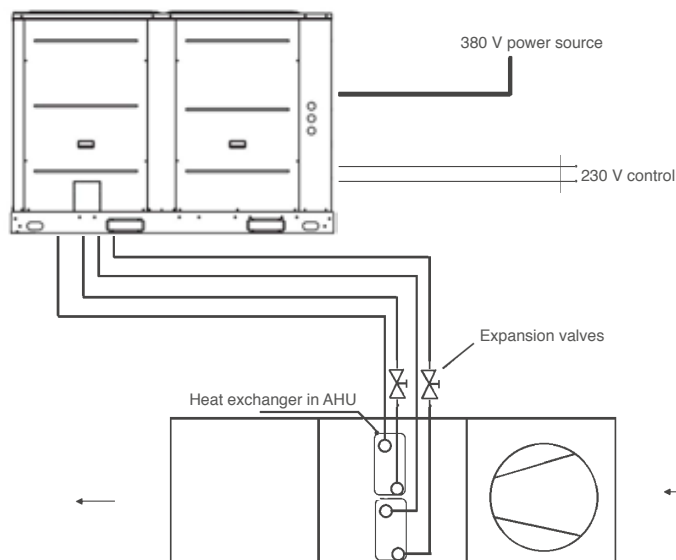

TECHNICAL DATA

Outdoor unit model			MCCU-53CN1	MCCU-61CN1	MCCU-70CN1	MCCU-105CN1
Valve set			CCU13N1	CCU13N1	CCU14N1	CCU15N1
Power source		V/phase/Hz	380~420/3/50	380~420/3/50	380~420/3/50	380~420/3/50
Cooling	Rated capacity	kW	53.0	61.0	70.0	105.0
	Rated input power	W	16.8	19.0	22.0	28.0
	EER		3.15	3.20	3.18	3.75
	Maximum input power	kW	25.8	29.8	33.2	42.1
	Maximum operating current	A	45.2	51.0	56.5	71.8
Sound pressure level		dB(A)	73	76	76	78
Expansion component			TZR x 2	TZR x 2	TZR x 2	TZR x 2
Dimensions (W x D x H)		mm	1825x899x1245	1825x899x1245	1844x924x1272	1844x924x1272
Shipping dimensions (W x D x H)		mm	2158x1082x1260	2158x1082x1670	2168x1105x1275	2168x1105x1686
Net/gross weight		kg	395/405	395/405	508/523	570/582
Piping	Liquid	mm	Ø12.7 x 2	Ø12.7 x 2	Ø12.7 x 2	Ø12.7 x 2
	Gas	mm	Ø25 x 2	Ø25 x 2	Ø25 x 2	Ø25 x 2
	Maximum length	m	50	50	50	50
	Maximum height difference	m	30	30	30	30
Recommended electric wiring	Power source cable	mm ²	4x16 + 1x10	4x25 + 1x16	4x25 + 1x16	4x35 + 1x16
	Communication cable	mm ²	2x1.5	2x1.5	2x1.5	2x1.5
	Fuse	A	60	70	80	100
Outdoor unit operation temperature range: cooling			°C	-7~43	-7~43	-7~43

The capacity is based on the following conditions:

Cooling: indoor temperature 27°C DB/19°C WB; outdoor temperature 35°C DB/24°C WB

Piping length: Connected pipes length 7.5 m, height difference 0.

The background is a solid purple color with several overlapping, semi-transparent white geometric shapes. These shapes include rounded rectangles and lines that create a sense of depth and movement. The shapes are arranged in a way that they appear to be layered, with some in the foreground and others receding into the background. The overall effect is a modern, abstract design.

CONTROL

CONTROL

WIRELESS CONTROLLER

Functions:

- On/Off
- Operation mode settings: auto, cooling, dry, heating, fan
- Fan speed settings: high, medium, low, auto
- Sleep mode
- Turbo mode
- Temperature settings (17-30°C)
- Air flow direction settings

RG52



SHORTCUT BUTTON

It allows reverting all the parameters: temperature setpoint, mode of operation and fan speed, to factory settings by mean of a single button push.

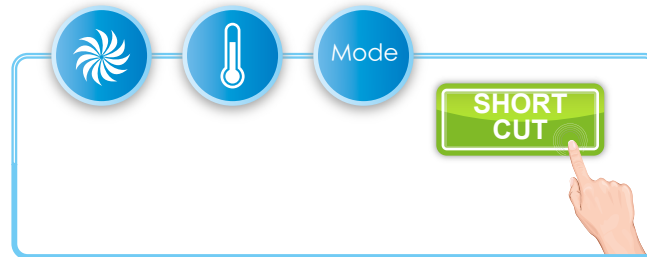

CLEAR USER INTERFACE

Setting of the air-conditioner operation parameters is presented on a display in a clear manner, therefore the users can adapt them precisely to their requirements.

SPECIFICATION

Model	R52
Dimensions (W x H x D) [mm]	130x54x18
Power source	1.5V(LR03/AAA)×2

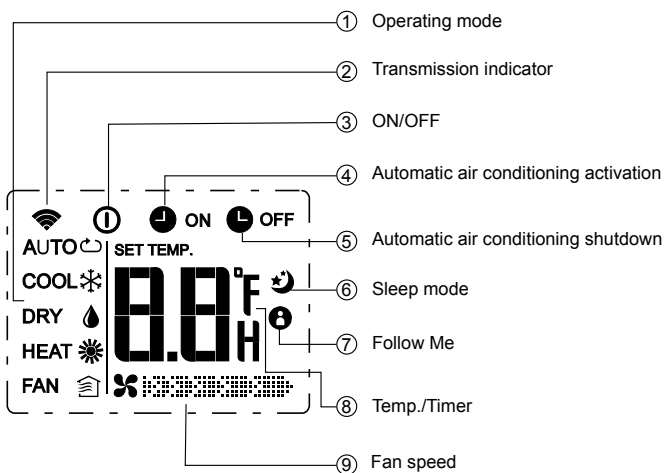

CONTROL

Functions:

- On/Off
- Operation mode settings: cooling, heating, dry, fan, auto
- Fan speed settings: low, medium, high, auto
- Sleep mode
- Turbo mode
- Economy operation mode
- Temperature settings (17-30°C)
- Operation time settings (Timer),
- Air flow direction settings

WIRELESS CONTROLLER

R51



RANGE

The R51 remote controller is a portable device. It enables control of the air-conditioner at a distance of up to 11 m from the unit.



BUILT-IN TIMER

The built-in timer provides the opportunity to program the time of air-conditioner automatic on and off switching in the following 24 hours.



Indoor unit is set for automatic operation from 8:00 till 20:00

CLEAR USER INTERFACE

Setting of the air-conditioner operation parameters is presented on a display in a clear manner, therefore the users can adapt them precisely to their requirements.

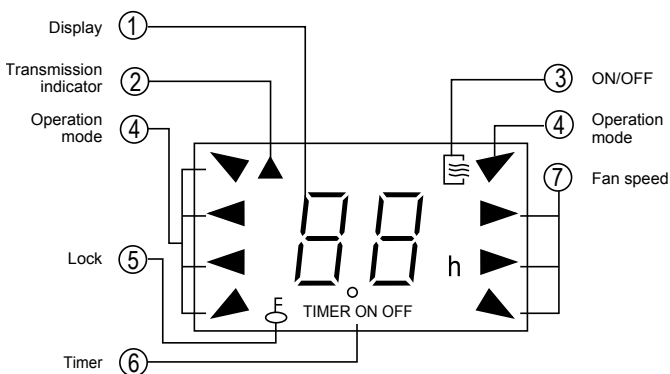

SPECIFICATION

Model	R51
Dimensions (W x H x D) [mm]	140×60×15
Power source	1.5V(LR03/AAA)×2

CONTROL

WIRED CONTROLLER

Functions:

- On/Off
- Clock settings
- Operation mode settings
- Fan speed settings
- Desired temperature settings
- Programmable Timer
- Silent operation
- Lock function
- Swing function
- Follow Me function

KJR-12B



FAN SPEED SETTING

Possibility to select from 4 fan speeds:
Auto, Low, Medium, High.



BUTTON LOCK

Activating the lock results in the wired controller no longer responding to the use of buttons. This prevents inadvertent use of the controller by unauthorized persons.

FOLLOW ME

This function enables the temperature sensor built-in the controller. This sensor substitutes another sensor installed in the indoor unit. The air-conditioner controls the air temperature in the immediate vicinity of the controller and therefore, the temperature adjustment is more accurate and comfortable.

Temperature sensor

Follow Me function button



SWING FUNCTION

In units equipped with the swing function, it allows to adjust the direction of air discharge.

Choice of direction
smooth swing

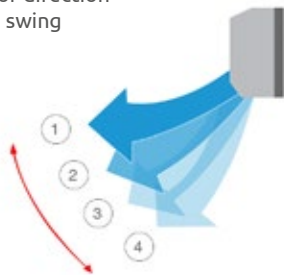

SPECIFICATION

Model	KJR-12B
Dimensions (W x H x D) [mm]	120×120×15
Power source	DC 5V

CONTROL

CENTRAL CONTROLLER

Functions:

- On/Off
- Operation mode change
- Individual or group control

KJR-90B



SIMPLIFIED CONTROL

Simplified central controller KJR-90B performs only the on/off function and changes the operation mode (cooling/heating) of the indoor unit. Operation temperature and other parameters are set on the individual controllers.



LED SIGNALLING

LED diodes on the KJR-90B remote controller display the current operation status of the indoor units and notify about occurred errors. After checking or changing the settings, the backlight dims thereby saving energy. The indications are as follows:

- blue diode colour - the air-conditioner operates in cooling or fan mode
- red diode colour - the air-conditioner operates in heating mode
- flashing diode - air-conditioner failure or error

CENTRAL CONTROL

Up to 16 indoor units can be connected to the central controller.



SPECIFICATION

Model	KJR-90B
Dimensions (W x H x D) [mm]	90×86×8
Power source	DC 5V

CONTROL

Functions:

- Connection of up to 64 air-conditioners
- Individual or group control
- On/Off
- Operation mode settings
- Fan speed settings
- Temperature setting
- Programmable Timer
- Lock function
- Swing function
- Cooling mode
- Heating mode
- Ventilation

CENTRAL CONTROLLER

MD-CCM03



CENTRAL CONTROLLER

The controller is a multifunction device, which can control operation of up to 64 indoor units. The maximum transmission cables length is 1200 m.



AIR-CONDITIONER OPERATION STATUS

Large, easily readable display presents many useful information. The controller informs about the number of connected air-conditioners, indicating at the same time the number of operating units and the number of units in standby mode. Operation parameters of each indoor unit can be checked on the controller, including room temperature readings and timer settings.

In case of any malfunction of one of the air-conditioners, an error code is indicated on the display.

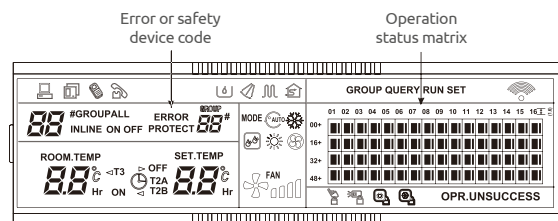

THREE LOCKING MODES

The MD-CCM03 controller is the perfect tool for the control of whole air-conditioning system operation. Besides standard control functions, there are also three type of locks:

Operation mode lock - locking the possibility of switching the air-conditioner on, for example in the heating mode in summer or in the cooling mode in winter.

Individual controllers lock - by activating the lock the air-conditioner may be controlled only from the central controller. The receiver of the infrared signal sent from the controller and the individual wired controller are locked.

Central controller keys lock - it protects the controller against entering unintended settings by unauthorised persons.

Operation mode locking

Wireless controller locking

Keyboard locking

SPECIFICATION

Model	MD-CCM03
Dimensions (W x H x D) [mm]	179x119x74
Power source	198-242V(50/60Hz)

HRV

HEAT RECOVERY VENTILATOR



VENTILATION DEVICES

HEAT RECOVERY VENTILATOR

HRV



PRINCIPLE OF OPERATION

HRV enthalpic recuperators are an extraordinary technology that enables supplying fresh air with minimum temperature difference in comparison to the temperature in a given room. A cross-flow heat exchanger made of a specially processed paper divides the streams of supplied and extracted air, ensuring that only fresh air is provided to the room and enabling efficient heat exchange.

MOISTURE RECOVERY

The microscopic pores in the recuperator membrane reduce to minimum the transpiration of water-soluble gases such as ammonia or hydrogen. Additionally, the membrane is made of specially processed paper, which supports transfer of moisture and, therefore, increased heat exchange efficiency.

EXTERNAL ELECTRIC HEATER (OPTIONAL)

The initial air heater is used to increase the temperature of air flowing into the ventilation centre. It is used in case of extremely low outdoor air temperatures that fall below -7°C , ensuring correct and uninterrupted functioning of the HRV ventilation centre. The initial heater is controlled by the M-Air Control 1 module and the temperature sensor. The thermostat monitors the air temperature inside the conduit and, in case of detecting temperature lower than set, allows the heater to operate.

ENTHALPIC HEAT EXCHANGER

The new environmentally friendly exchanger provides the highest efficiency total heat exchange. The application of enthalpic exchanger makes it possible to obtain savings in building heating costs. The increased energy savings result also from limiting the air conditioning load and improved moisture transpiration. The HRV recuperator maintains optimal humidity of air supplied to rooms, thanks to which the air humidifying system is not necessary. The condensate drainage system is also unnecessary, since moisture is not condensed to the exchanger, but transferred to the stream of supplied air.

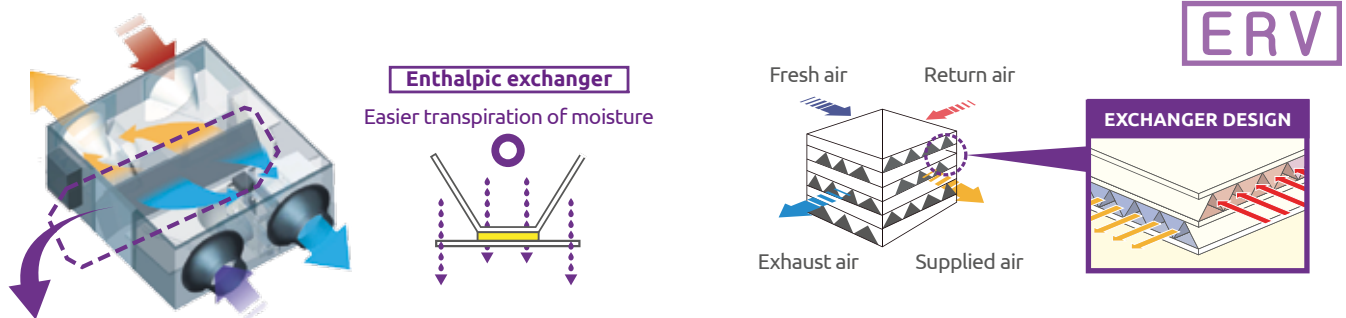

ADVANTAGES OF RECUPERATION WITH THE USE OF HRV

For a single-family house the annual costs of heating the air that is lost through the natural ventilation system can amount to as much as 50% of the total building heating cost. By using a mechanical ventilation system we can reduce the building heating bill by as much as ca. 30%. What becomes an indispensable element of such a building is the recuperator with heat recovery. The Nabilaton company offers enthalpic HRV recuperators that recover energy and are perfect for every type of building, e.g. passive buildings, energy-saving buildings or thermally modernized buildings.

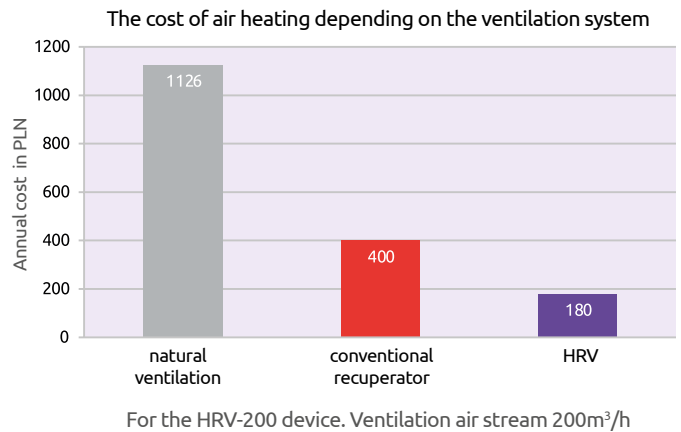

COMPARISON OF HEAT RECOVERY IN CONVENTIONAL AND ENTHALPIC RECUPERATION SYSTEMS

The HRV Energy Recovery Technology and simultaneous supply and extraction of air ensure perfect quality of air in the room and significant reduction in demand for external air.

Conventional recuperator (winter)

Heat recovery $q \times n = Q_{\text{recovery}}$
 Sensible heat - $60\text{W} \times 0.8 = 48\text{W}$
 Latent heat - 0W
 Total heat recovery: 48W

Total heat - 120W
 Sensible heat - 60W
 Latent heat - 60W
 $Q_{\text{cal}} = 60\text{W} + 60\text{W} = 120\text{W}$

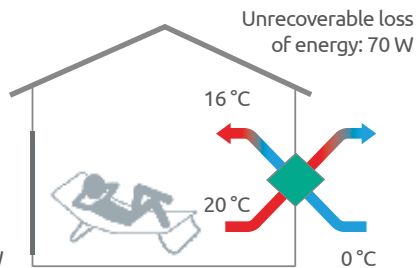

Enthalpic recuperator (winter)

Heat recovery $q \times n = Q_{\text{recovery}}$
 Sensible heat - $60\text{W} \times 0.8 = 48\text{W}$
 Latent heat - $60\text{W} \times 0.7 = 42\text{W}$
 Total heat recovery: 90W

Total heat - 120W
 Sensible heat - 60W
 Latent heat - 60W
 $Q_{\text{cal}} = 60\text{W} + 60\text{W} = 120\text{W}$

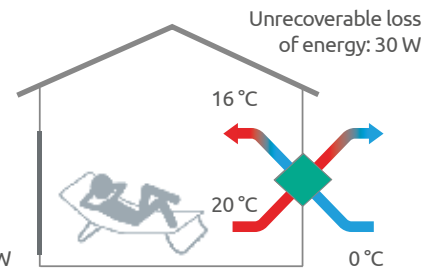

ERV

FREE COOLING COOPERATION WITH HEAT PUMP AND AIR CONDITIONING

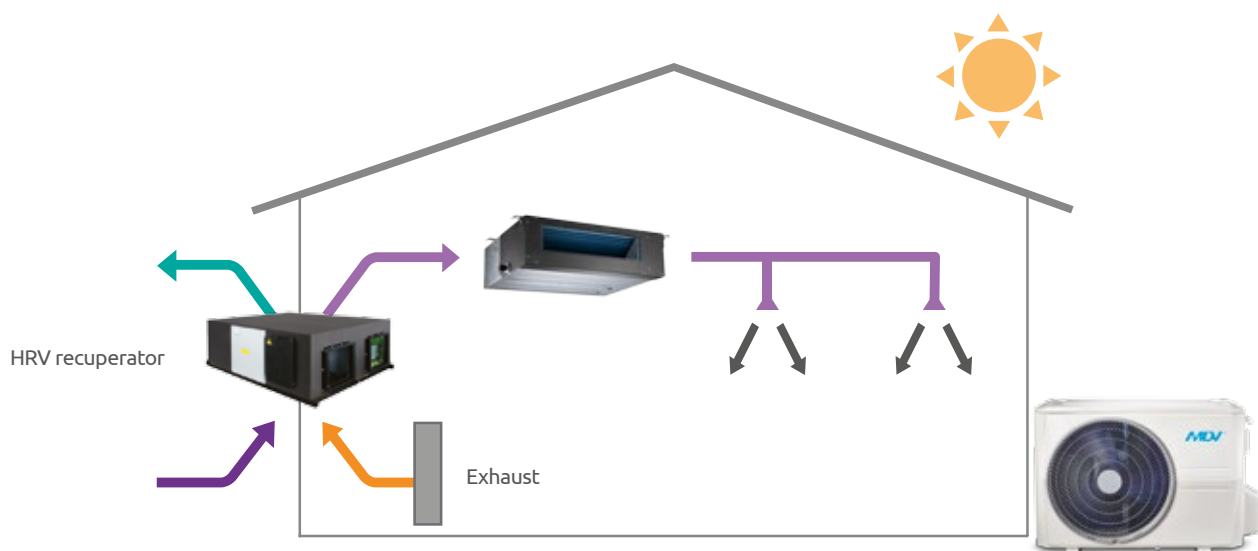

HRV-200

Model		HRV-200			
Power source	Hz/-V	50/1/220-240			
Speed		Low	Medium	High	
Nominal air flow	m ³ /h	150	200	200	
Temperature-based recovery efficiency	%	70.0	65.0	65.0	
Enthalpy recovery efficiency	heating	%	60.0	55.0	55.0
	cooling	%	55.0	50.0	50.0
Sound pressure level in the heat exchange mode	dB(A)	20	26	27	
External static pressure	Pa	35	58	75	
Power consumption	kW	0.02	0.02	0.02	
Rated current	A	0.5	0.5	0.5	
Total dimensions	height	mm	264	264	264
	width	mm	866	866	866
	depth	mm	655	655	655
Weight	kg	23	23	23	
Connection ports: fresh air inlet, exhaust / air supply, air return	mm	4 x Ø144			

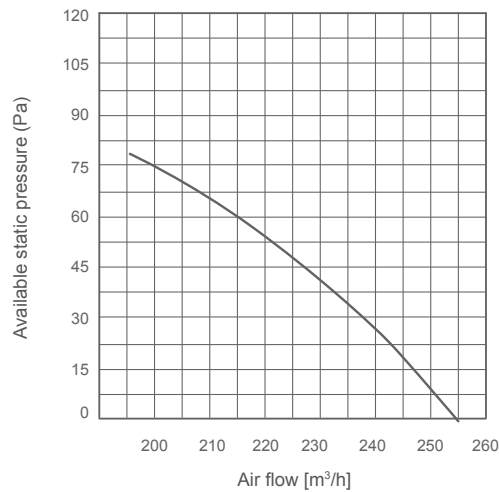

Installation dimensions

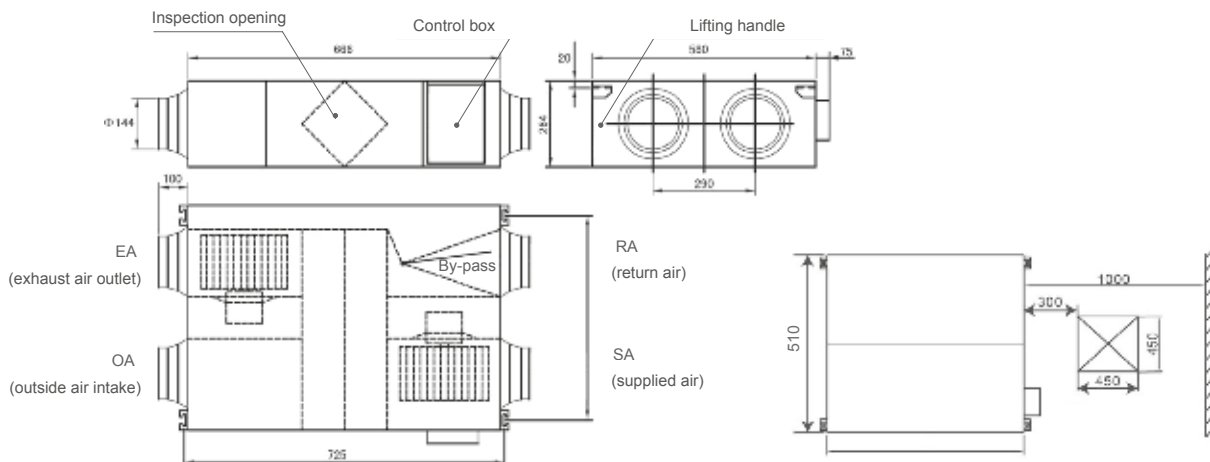

TECHNICAL DATA

HRV-300

Model		HRV-300		
Power source	Hz/-V	50/1/220-240		
Speed		Low	Medium	High
Nominal air flow	m ³ /h	225	300	300
Temperature-based recovery efficiency	%	70.0	65.0	65.0
Enthalpy recovery efficiency	heating	%	60.0	55.0
	cooling	%	55.0	50.0
Sound pressure level in the heat exchange mode	dB(A)	23	29	30
External static pressure	Pa	40	60	75
Power consumption	kW	0.04	0.04	0.04
Rated current	A	0.56	0.56	0.56
Total dimensions	height	mm	270	270
	width	mm	944	944
	depth	mm	722	722
Weight	kg	26	26	26
Connection ports: fresh air inlet, exhaust / air supply, air return	mm	4 x Ø144		

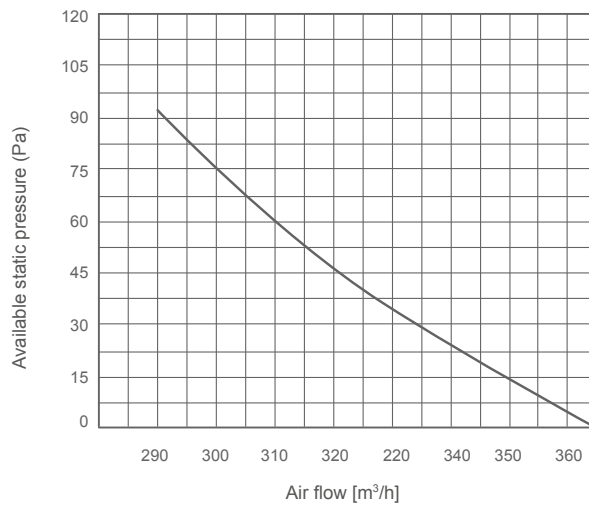

Installation dimensions

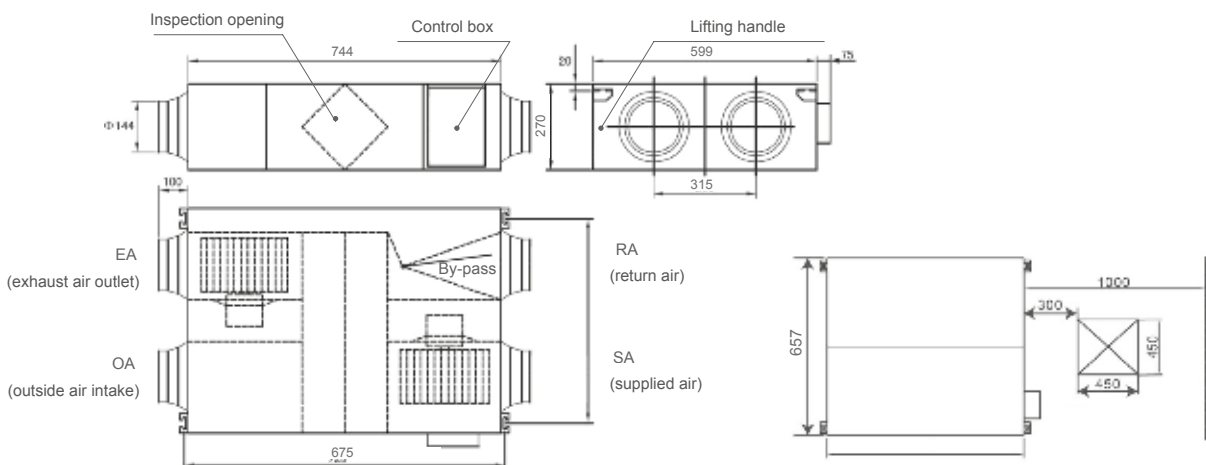

HRV-400

Model		HRV-400			
Power source	Hz/-V	50/1/220-240			
Speed		Low	Medium	High	
Nominal air flow	m ³ /h	300	400	400	
Temperature-based recovery efficiency	%	70.0	65.0	65.0	
Enthalpy recovery efficiency	heating	%	65.0	60.0	60.0
	cooling	%	55.0	50.0	50.0
Sound pressure level in the heat exchange mode	dB(A)	25	31	32	
External static pressure	Pa	43	65	80	
Power consumption	kW	0.08	0.08	0.08	
Rated current	A	1	1	1	
Total dimensions	height	mm	270	270	270
	width	mm	944	944	944
	depth	mm	927	927	927
Weight	kg	30	30	30	
Connection ports: fresh air inlet, exhaust / air supply, air return	mm	4 x Ø144			

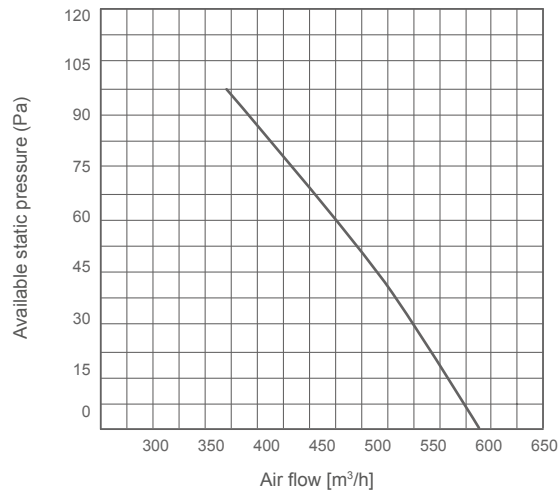

Installation dimensions

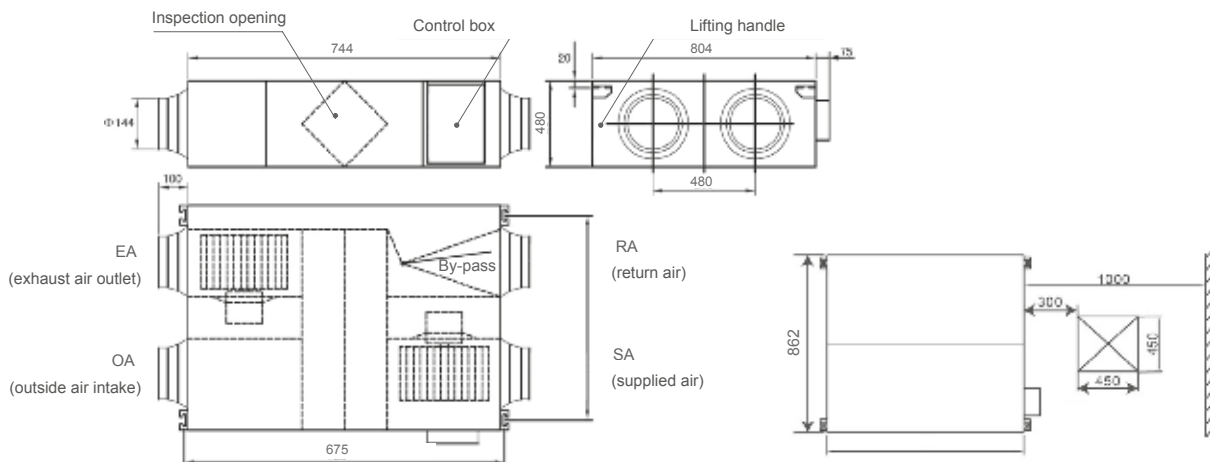

TECHNICAL DATA

HRV-500

Model			HRV-500		
Power source	Hz/-V	50/1/220-240			
Speed		Low	Medium	High	
Nominal air flow	m ³ /h	375	500	500	
Temperature-based recovery efficiency	%	70.0	65.0	65.0	
Enthalpy recovery efficiency	heating	%	65.0	60.0	60.0
	cooling	%	55.0	50.0	50.0
Sound pressure level in the heat exchange mode	dB(A)	28	34	35	
External static pressure	Pa	45	68	80	
Power consumption	kW	0.12	0.12	0.12	
Rated current	A	1	1	1	
Total dimensions	height	mm	270	270	270
	width	mm	1038	1038	1038
	depth	mm	1026	1026	1026
Weight	kg	41	41	41	
Connection ports: fresh air inlet, exhaust / air supply, air return	mm	4 x Ø194			

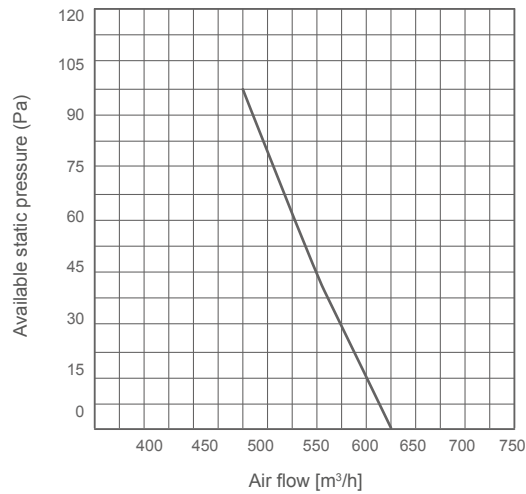

Installation dimensions

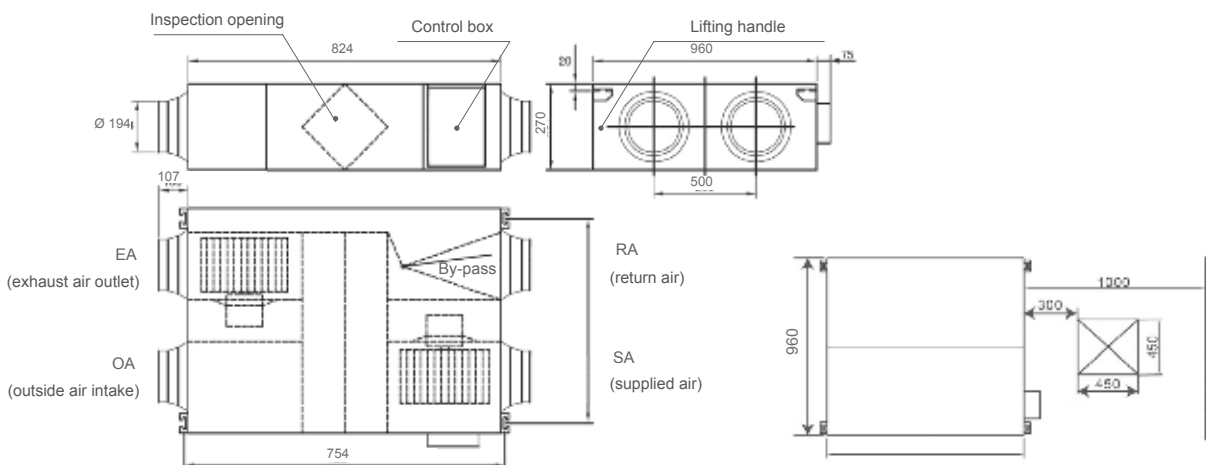

TECHNICAL DATA

HRV-800

Model		HRV-800			
Power source	Hz/-V	50/1/220-240			
Speed		Low	Medium	High	
Nominal air flow	m ³ /h	600	800	800	
Temperature-based recovery efficiency	%	70.0	70.0	70.0	
Enthalpy recovery efficiency	heating	%	65.0	60.0	60.0
	cooling	%	55.0	50.0	50.0
Sound pressure level in the heat exchange mode	dB(A)	32	38	39	
External static pressure	Pa	54	82	100	
Power consumption	kW	0.36	0.36	0.36	
Rated current	A	2	2	2	
Total dimensions	height	mm	388	388	388
	width	mm	1286	1286	1286
	depth	mm	1006	1006	1006
Weight	kg	62	62	62	
Connection ports: fresh air inlet, exhaust / air supply, air return	mm	4 x Ø242			

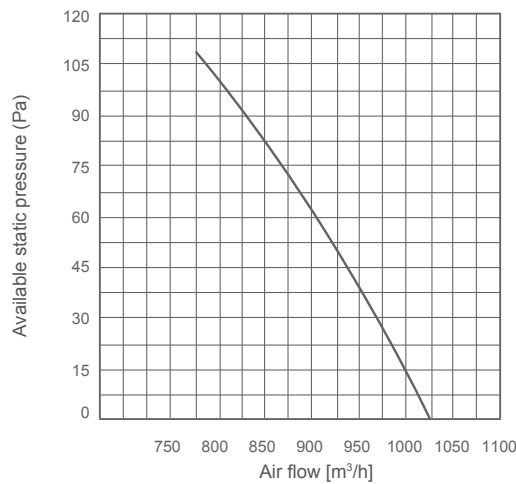

Installation dimensions

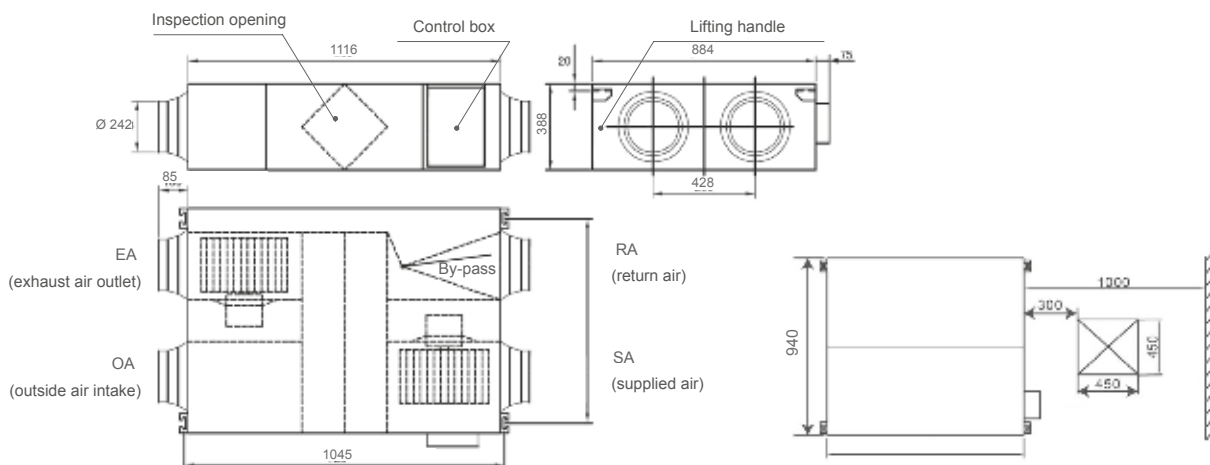

TECHNICAL DATA

HRV-1000

Model		HRV-1000		
Power source	Hz/-V	50/1/220-240		
Speed		Low	Medium	High
Nominal air flow	m ³ /h	750	1000	1000
Temperature-based recovery efficiency	%	70.0	65.0	65.0
Enthalpy recovery efficiency	heating	%	65.0	60.0
	cooling	%	55.0	50.0
Sound pressure level in the heat exchange mode	dB(A)	33	39	40
External static pressure	Pa	58	85	120
Power consumption	kW	0.36	0.36	0.36
Rated current	A	2.4	2.4	2.4
Total dimensions	height	mm	388	388
	width	mm	1286	1286
	depth	mm	1256	1256
Weight	kg	79	79	79
Connection ports: fresh air inlet, exhaust / air supply, air return	mm	4 x Ø242		

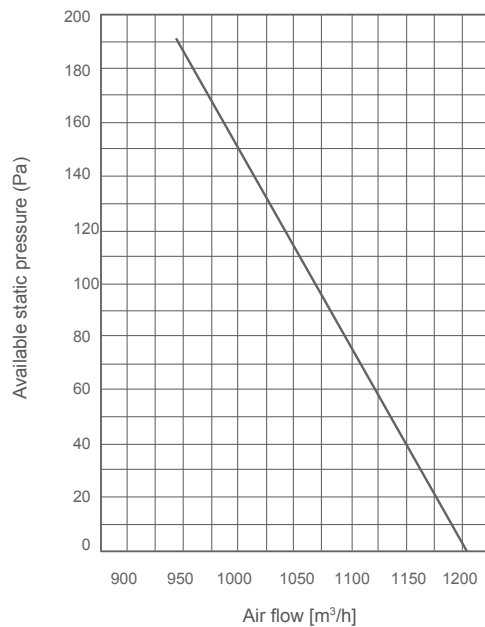

Installation dimensions

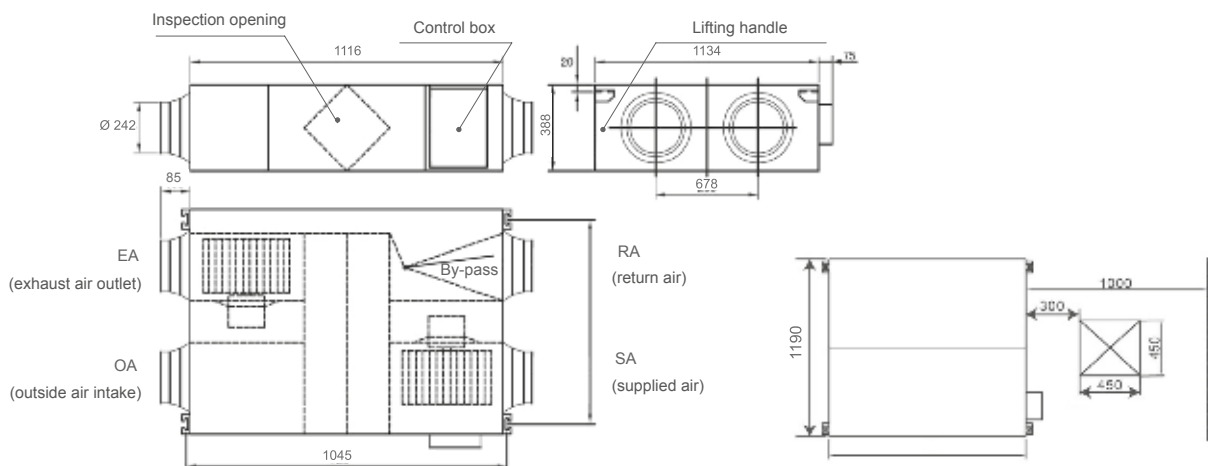

HRV-1500

Model		HRV-1500	
Power source	Hz/-V	50/1/220-240	
Speed		High	
Nominal air flow	m ³ /h	1500	
Temperature-based recovery efficiency	%	70.0	
Enthalpy recovery efficiency	heating	%	60.0
	cooling	%	50.0
Sound pressure level in the heat exchange mode	dB(A)	51	
External static pressure	Pa	160	
Power consumption	kW	0.45	
Rated current	A	3.2	
Total dimensions	height	mm	540
	width	mm	1600
	depth	mm	1270
Weight	kg	163	
Connection ports: fresh air inlet, exhaust / air supply, air return	mm	346 x 326 (x4)	

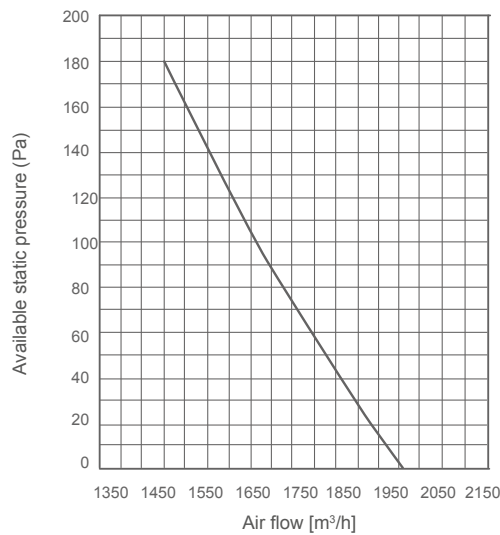

Installation dimensions

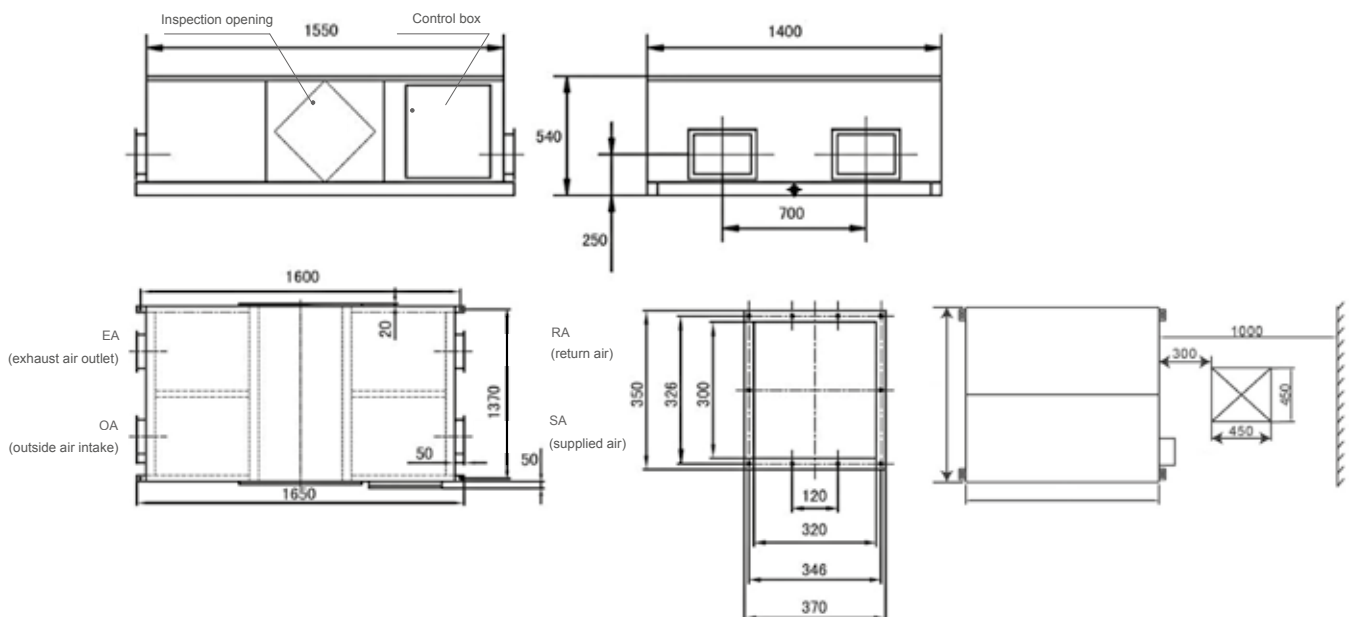

HRV-2000

Model		HRV-2000	
Power source	Hz/-V	50/1/220-240	
Speed		High	
Nominal air flow	m ³ /h	2000	
Temperature-based recovery efficiency	%	70.0	
Enthalpy recovery efficiency	heating	%	60.0
	cooling	%	50.0
Sound pressure level in the heat exchange mode	dB(A)	53	
External static pressure	Pa	170	
Power consumption	kW	0.45	
Rated current	A	3.6	
Total dimensions	height	mm	540
	width	mm	1650
	depth	mm	1470
Weight	kg	182	
Connection ports: fresh air inlet, exhaust / air supply, air return	mm	346 x 326 (x4)	

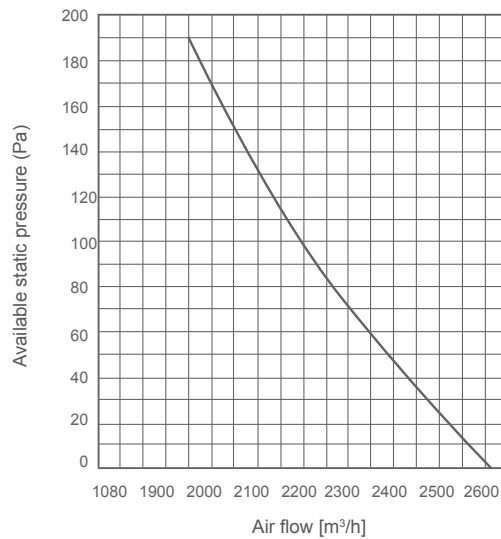

Installation dimensions

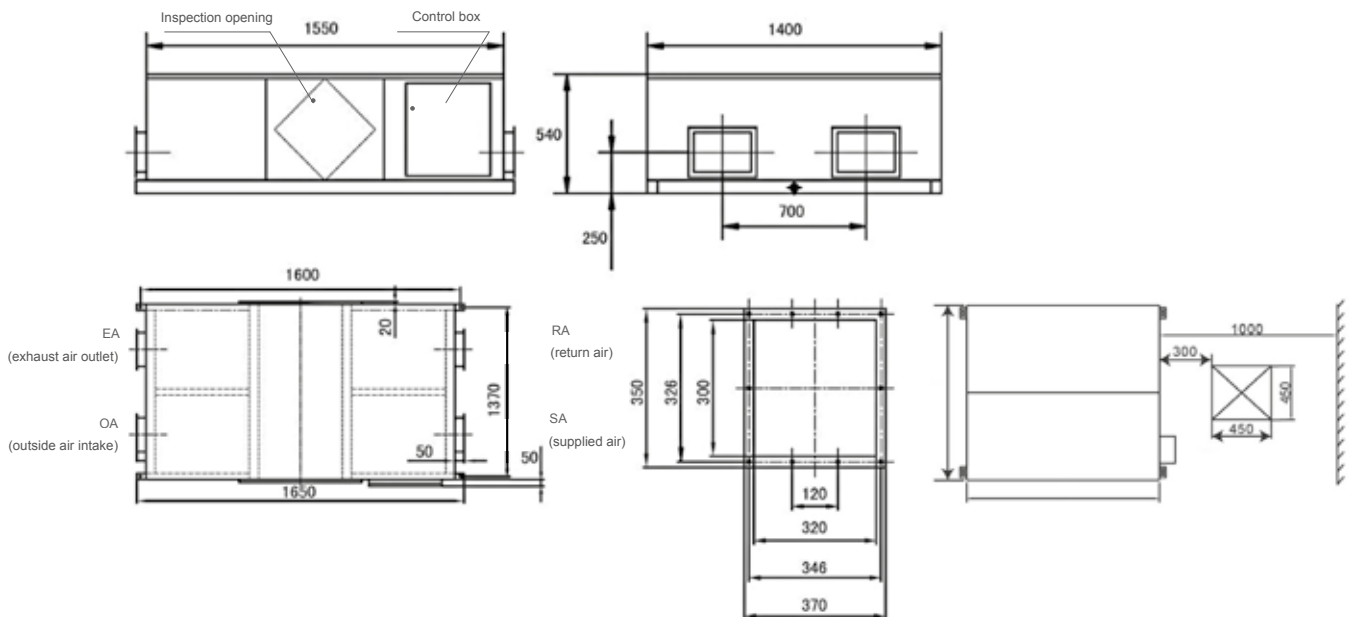

AIR CURTAINS



AIR CURTAINS

ELECTRICAL

Blue King



GENERAL INFORMATION

Air curtains are fitted with centrifugal fan with spiral forward-inclined blades, thanks to which they ensure high air flow (air flow speed up to 20 m/s) and at the same time they ensure silent operation. Housing made of sheet steel in white colour, with fire-proof structure. In the curtains there have been applied heaters of the PTC type that eliminate the risk of avalanche breakdowns or short-circuiting even at high air humidity. The blow of cool or warm air is controlled by a microprocessor. Activation of the fan takes place 3 minutes after curtain shutdown in order to protect the heater against overheating (this security is active also during normal operation).

INTENDED USE

Air curtains are dedicated for operation in commercial rooms, commercial activity, public sector, industry and cold stores.

TECHNICAL DATA

Cold curtain

Model	Voltage	Power consumption	Airflow	Air velocity	Max. sound pressure level	Dimensions	Weight
	V/phase/Hz	W	m ³ /h	m/s	dB(A)	W x D x H	kg
ACC101000A.BK	220/1/50	170	1050	8	<57	1000x215x195	18.5

Heat curtain

Model	Voltage	Heater power	Power consumption	Airflow	Air velocity	Max. sound pressure level	Dimensions	Weight
	V/phase/Hz	kW	W	m ³ /h	m/s	dB(A)	W x D x H	kg
ACH101045E.BK	220/1/50	4.5	170	1050	8	<57	1000x215x195	18.5
ACH151055E.BK	220/1/50	5.5	220	1800	8	<59	1500x215x195	29.0
ACH203100E.BK	220/1/50	10.0	320	2400	8	<61	2000x215x195	36.0

DEVICE DIMENSIONS

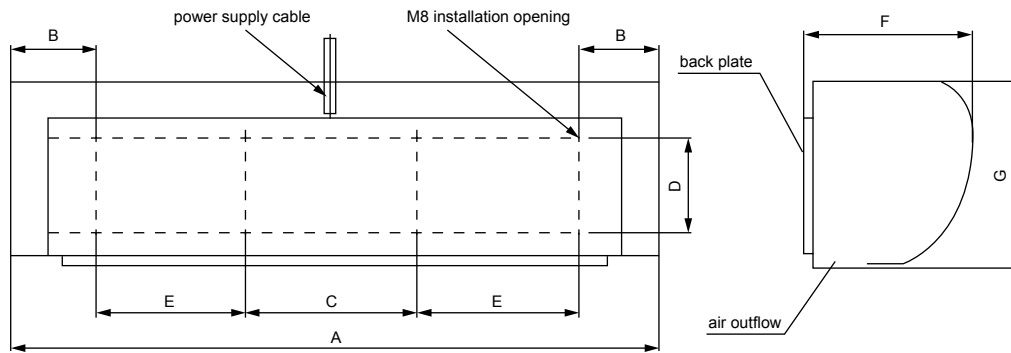

Model			ACC101000A.BK	ACH101045E.BK	ACH151055E.BK	ACH203100E.BK
Dimensions	A	mm	1000	1000	1500	2000
	B	mm	35	35	35	35
	C	mm	240	240	360	360
	D	mm	100	100	100	100
	E	mm	300	300	360	360
	F	mm	220	220	220	220
	G	mm	195	195	195	195

BLUE KING - WIRELESS CONTROLLER FOR AIR CURTAINS







General representative of MDV in Poland

S/001/2016

www.aircon.pl