

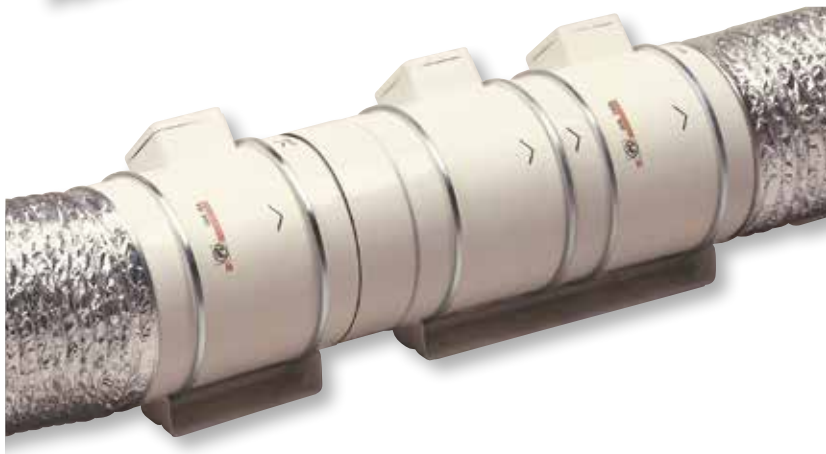

The MIXVENT System includes a specific range of accessories enabling the installation of different combinations of the MIXVENT-TD maintaining the concept that makes the difference: deliver the maximum airflow using the minimum space.

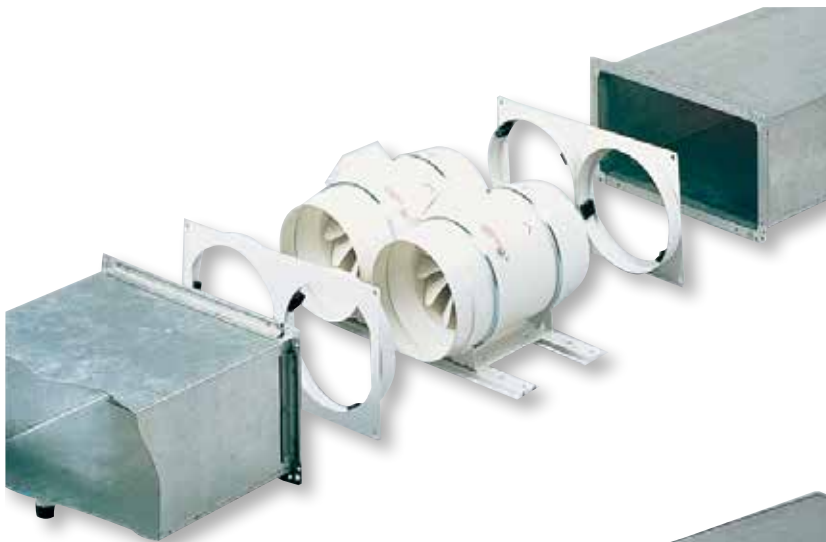

TDx2 MIXVENT and TDx3 MIXVENT
To increase the pressure.



TWIN MIXVENT
To double the airflow.

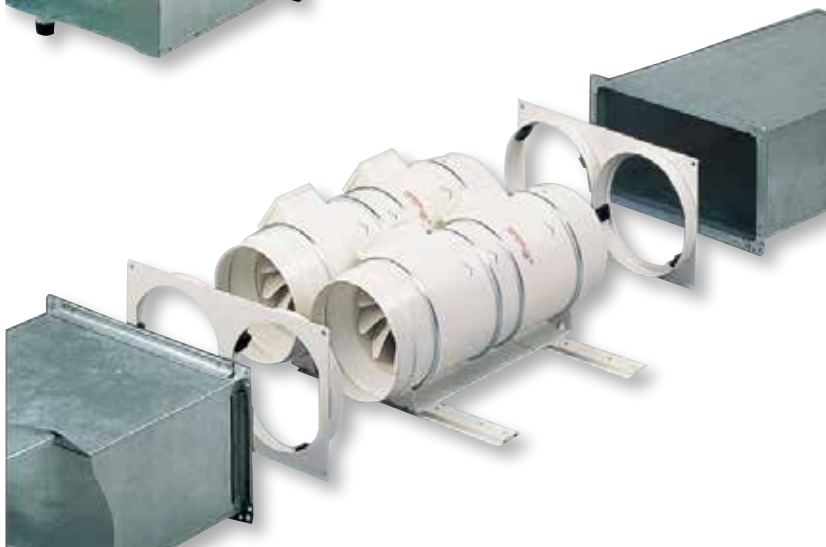

TWINx2 MIXVENT
To increase the pressure and double the airflow.



The MIXVENT-TDx2 range consists of two MIXVENTTD fans mounted in series to produce almost twice the pressure of the single TD fan. System specially recommended when the fan has the suitable airflow and when an increase of the pressure is required due to the high pressure drops. MIXVENT-TDx2 are standard catalogue products, from 350 to 1300 model. A TDx2 can also be obtained coupling 2 TD model fans using a flange MBR (see the accessories section).

TECHNICAL CHARACTERISTICS

TDx2 MIXVENT	Speed (rpm)	Maximum absorbed power (W)	Maximum absorbed current (A)	Airflow at free discharge (m³/h)	Operating temperature (°C)	Sound pressure level* (dB(A))	Weight (kg)
TDx2-350/125	2250	60	0,26	395	-20/+40	36	5,4
	1900	44	0,20	320		31	
TDx2-500/160	2500	100	0,44	580	-20/+60	48	5,0
	1950	88	0,38	475		41	
TDx2-800/200N	2780	140	0,60	880	-20/+60	48	8,7
	2480	120	0,52	690		44	
TDx2-800/200	2500	240	1,00	1.020	-20/+60	52	8,7
	2000	200	0,90	790		48	
TDx2-1000/250	2800	250	1,00	1.020	-40/+60	57	18,7
	2610	170	0,70	900		51	
TDx2-1300/250	2520	360	1,60	1.320	-40/+60	57	18,7
	2000	280	1,20	980		52	

* Sound pressure level radiated at 3 m at free air conditions with rigid ducts at the inlet and at the outlet.

DIMENSIONS (mm)

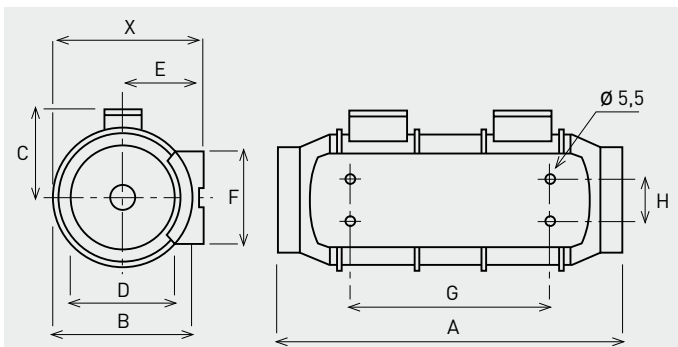

TDx2 MIXVENT	X	A	Ø B	C	Ø D	E	F	G	H
TDx2-350/125	188,0	417	176	115	123	100	90	253	60
TDx2-500/150	212,5	464	200	127	147	111,5	130	249	60
TDx2-500/160	212,5	444	200	127	147	111,5	130	249	60
TDx2-800/200	232,5	500	217	141	198	124	140	298	94
TDx2-1000/250	291,0	654	272	192	248	155	168	416	145
TDx2-1300/250	291,0	654	272	192	248	155	168	416	145

ACOUSTIC POWER SPECTRUM IN DB(A) FOR EVERY FREQUENCY BAND AT THE INLET AND RADIATED, AT A HIGH SPEED.

AT THE INLET									RADIATED								
	63	125	250	500	1000	2000	4000	8000		63	125	250	500	1000	2000	4000	8000
TDx2-350/125	41	53	52	59	60	56	47	39	TDx2-350/125	39	52	52	53	53	51	39	30
TDx2-500/150	38	41	61	63	65	68	62	54	TDx2-500/150	31	38	49	45	50	59	48	35
TDx2-500/160	38	41	61	63	65	68	62	54	TDx2-500/160	31	38	49	45	50	59	48	37
TDx2-800/200N	43	48	68	70	72	70	66	58	TDx2-800/200N	32	38	54	53	58	59	50	58
TDx2-800/200	43	53	67	69	74	73	70	60	TDx2-800/200	35	42	53	52	60	63	54	39
TDx2-1000/250	41	51	64	72	78	75	68	60	TDx2-1000/250	29	40	50	52	64	63	52	49
TDx2-1300/250	43	58	70	73	81	79	72	67	TDx2-1300/250	28	42	45	53	66	65	58	53

IN-LINE MIXED FLOW DUCT FANS

TDx2 MIXVENT System



PERFORMANCE CURVES

- q_v : Airflow in m^3/h and m^3/s .
- p_{sf} : Static pressure in mmWG and Pa.
- Dry air at 20°C and 760 mmHg.
- Performance data in accordance with ISO 5801 and AMCA 210-99 Standards.

HS: High speed
LS: Low speed

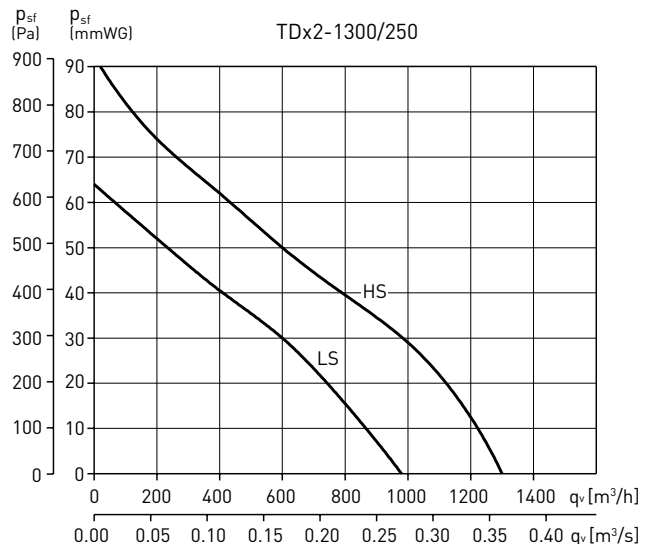
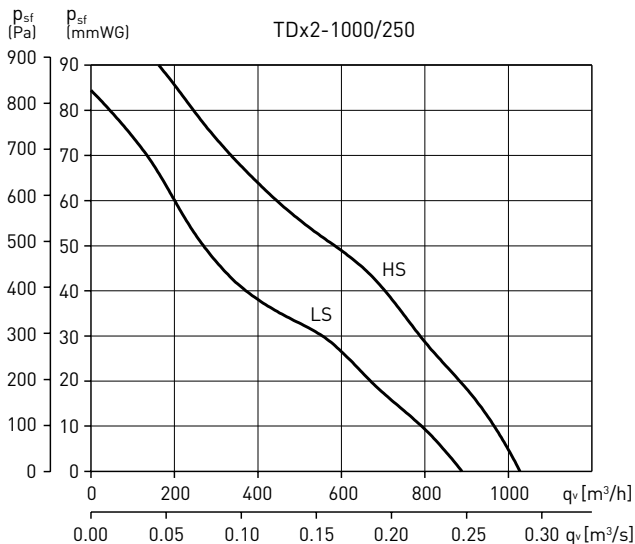
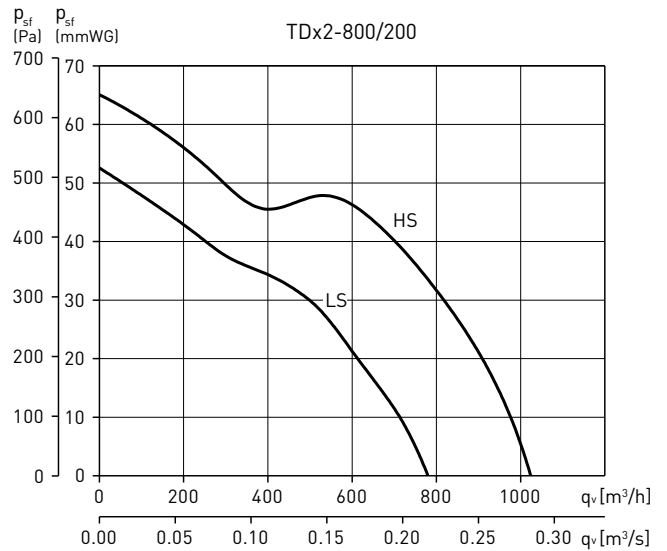
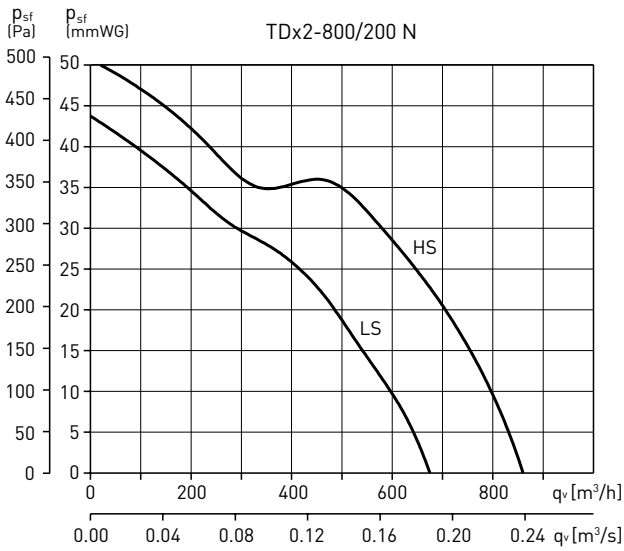
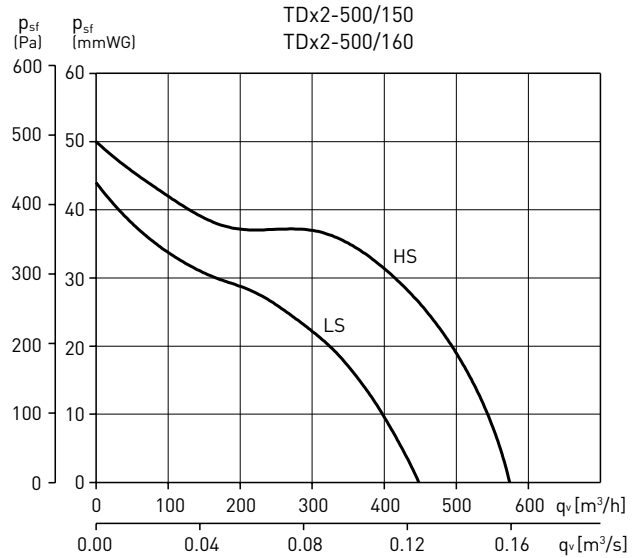
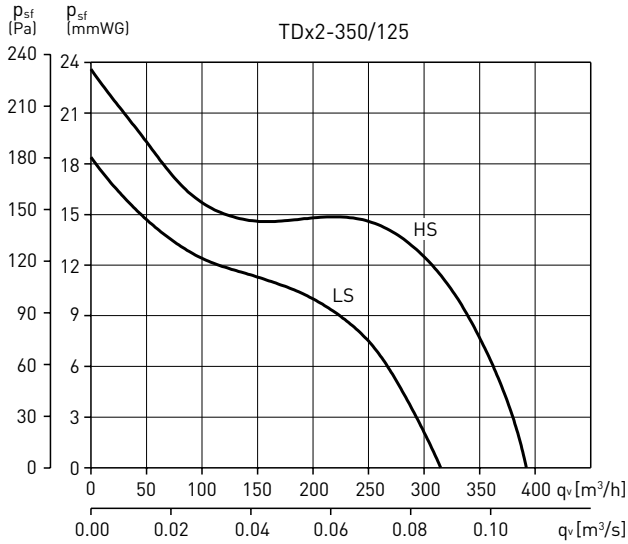

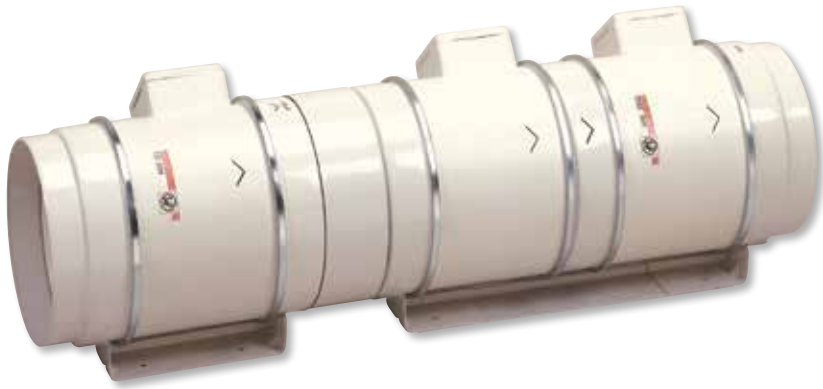

The MIXVENT-TDx3 range consists of a MIXVENTTDx2 and MIXVENT-TD fans mounted in series using the flange MBR. System specially recommended when the fan has the suitable airflow and when an important increase of the pressure is required due to the very high pressure drop. Technically more units could be installed in series to increase the pressure but it is recommended to carry out a study before.

MIXVENT-TDX3 Design



TDx3 MIXVENT	Composition
TDx3-350/125	TD-350/125+TDx2-350/125+MBR-350
TDx3-500/150	TD-500/150+TDx2-500/150+MBR-500/150
TDx3-500/160	TD-500/160+TDx2-500/160+MBR-500/160
TDx3-800/200	TD-800/200+TDx2-800/200+MBR-800
TDx3-1000/250	TD-1000/250+TDx2-1000/250+MBR-1000
TDx3-1300/250	TD-1300/250+TDx2-1300/250+MBR-1000



MBR flange

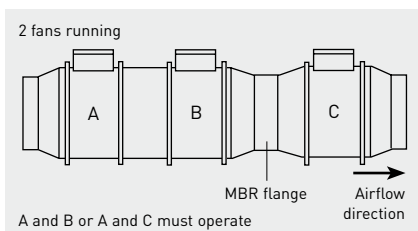
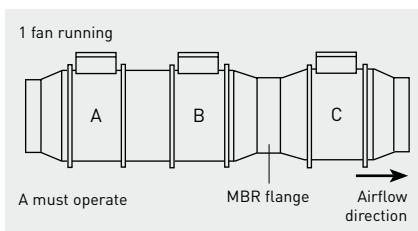

PERFORMANCE CURVES

- q_v : Airflow in m^3/h and m^3/s .
- p_{sf} : Static pressure in mmWG and Pa.
- Dry air at 20°C and 760 mmHg.
- Performance data in accordance with ISO 5801 and AMCA 210-99 Standards.

①	TDx3-350
②	TDx3-500
③	TDx3-800
④	TDx3-1000
⑤	TDx3-1300

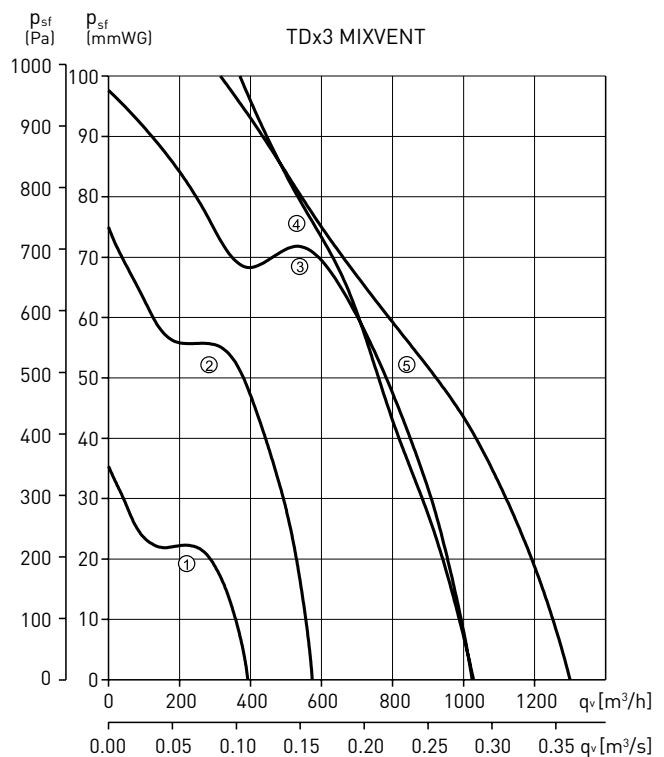

DIMENSIONS (mm)

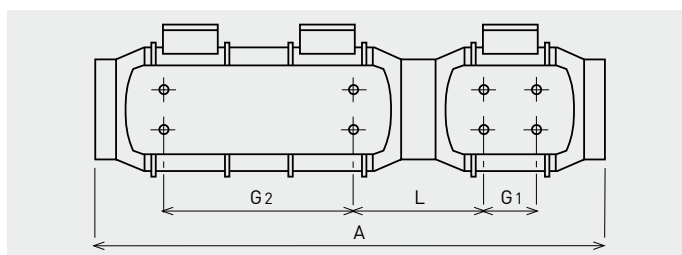

TDx3 MIXVENT	A	G1	G2	L
TD x 3-350/125	755	80	253	213
TD x 3-500/150	766	80	249	223
TD x 3-500/160	726	80	249	203
TD x 3-800/200	801	100	298	207
TD x 3-1000/250	1055	145	416	246
TD x 3-1300/250	1055	145	416	246



TWIN MIXVENT System

MIXVENT-TWIN system with backdraft shutter fitted

The MIXVENT-Twin consists of two MIXVENTTD fans mounted in parallel using the Kit Twin Base (suitable from 250 to 2000 model).

System specially recommended when a large airflow is required (at the same pressure) within a confined space, or where a supplementary airflow is occasionally needed.

Once mounted, the whole assembly is ready to be connected to a rectangular duct using the two rectangular flanges supplied with the Kit Twin Base.

The independent operation of two MIXVENT-TD requires the use of back draft shutters at the discharge (outlet) in order to prevent the air recycling through the stationary fan.

It is also needed in installations where it is necessary to mount at the same place, two fans with the same supply characteristics, for extraction and supply operations.

ACCESSORIES TO MOUNT MIXVENT-TWIN SYSTEM

KIT TWIN BASE-250 + 2 TD -160/100
KIT TWIN BASE-250 + 2 TD 250/100
KIT TWIN BASE-350 + 2 TD -350/125

KIT TWIN BASE-500/150 + 2 TD-500/150
KIT TWIN BASE-500/160 + 2 TD-500/160
KIT TWIN BASE-800 + 2 TD-800/200

KIT TWIN BASE-1000 + 2 TD-1000/250
KIT TWIN BASE-1000 + 2 TD-1300/250
KIT TWIN BASE-2000 + 2 TD-2000/315

Backdraft shutter, see accessories page.

KIT TWIN BASE

This accessory consists of two rectangular duct couplings with standardized dimensions and two supports allowing mounting two TD or two TDx2 fans in parallel.



KIT TWIN BASE	Dimensions (mm)		Nominal dimensions of the rectangular duct (mm)	
	L	H	L	H
KIT TWIN BASE 250	320	180	280	140
KIT TWIN BASE 350	320	180	280	140
KIT TWIN BASE 500/150	395	220	355	180
KIT TWIN BASE 500/160	395	220	355	180
KIT TWIN BASE 800	440	240	400	200
KIT TWIN BASE 1000	540	290	500	250
KIT TWIN BASE 2000	690	355	630	315

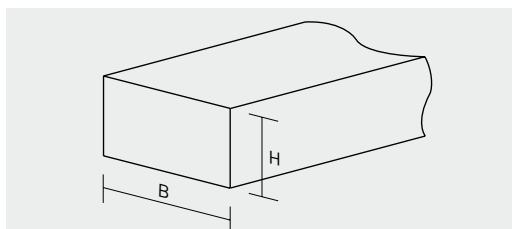

The independent operation of two MIXVENT-TD requires the use of back draft shutters at the discharge (outlet) in order to prevent the air recycling through the stationary fan.

DIMENSIONS (mm)

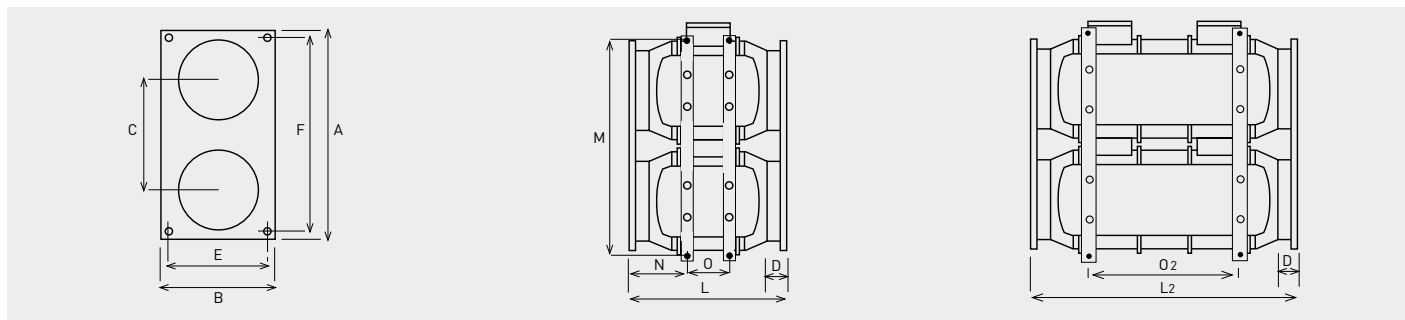

Model	A	B	C	D	E	F	L	L ₂	M	N	O	O ₂
TWIN-250	320	180	184	36	160	300	305	-	375	113	80	-
TWIN-350	320	180	184	33,5	160	300	305	475	333	91	80	253
TWIN-500 (150)	395	220	206	37	200	375	310	481	417	110	80	249
TWIN-500 (160)	395	220	206	37	200	375	290	461	417	100	80	249
TWIN-800	440	240	225	37	220	420	317	509	456	103	100	298
TWIN-1000	540	290	282	44	270	520	401	679	566	123	145	416
TWIN-1300	540	290	282	44	270	520	401	679	566	123	145	416
TWIN-2000	690	355	347	53	335	650	451	-	699	136	182	-

PERFORMANCE CURVES

- q_v : Airflow in m^3/h and m^3/s .
- p_{sf} : Static pressure in mmWG and Pa.
- Dry air at 20°C and 760 mmHg.
- Performance data in accordance with ISO 5801 and AMCA 210-99 Standards.

①	TWIN-350
②	TWIN-500
③	TWIN-800
④	TWIN-1000
⑤	TWIN-1300
⑥	TWIN-2000

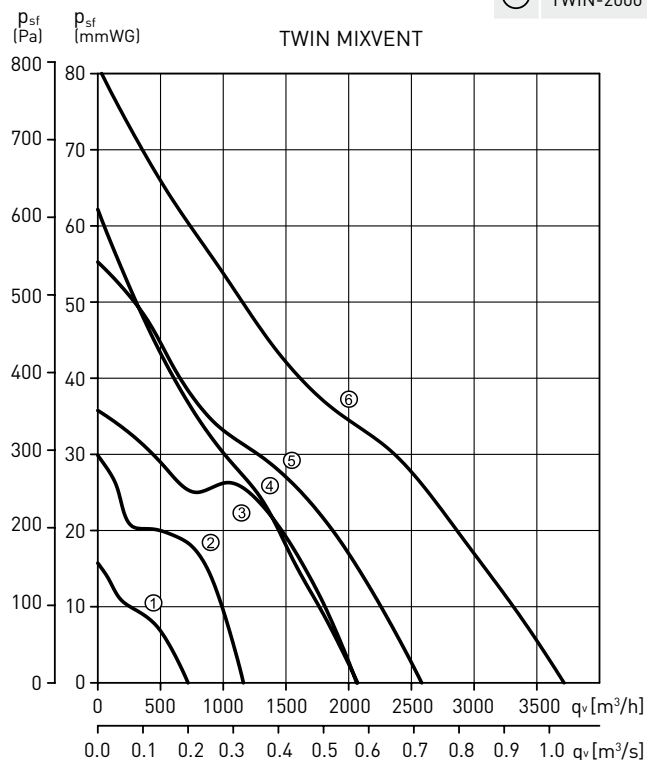

ACOUSTIC POWER SPECTRUM IN DB(A) FOR EVERY FREQUENCY BAND AT THE INLET AND RADIATED, AT A HIGH SPEED

AT THE INLET	63	125	250	500	1000	2000	4000	8000
TWIN-350/125	38	50	49	56	57	53	44	36
TWIN-500/150	35	38	58	60	62	65	59	51
TWIN-500/160	35	38	58	60	62	65	59	51
TWIN-800/200N	40	45	65	67	69	67	63	55
TWIN-800/200	40	50	64	66	71	70	67	57
TWIN-1000/250	38	48	61	69	75	72	65	57
TWIN-1300/250	40	55	67	70	78	76	69	64
TWIN-2000/315	44	60	69	74	80	77	70	65

RADIATED	63	125	250	500	1000	2000	4000	8000
TWIN-350/125	36	49	49	50	50	48	36	27
TWIN-500/150	28	35	46	42	47	56	45	32
TWIN-500/160	28	35	46	42	47	56	45	32
TWIN-800/200N	29	35	51	50	55	56	47	34
TWIN-800/200	32	39	50	49	57	60	51	36
TWIN-1000/250	26	37	47	49	61	60	49	46
TWIN-1300/250	25	39	42	50	63	62	55	50
TWIN-2000/315	32	44	55	58	67	66	60	56

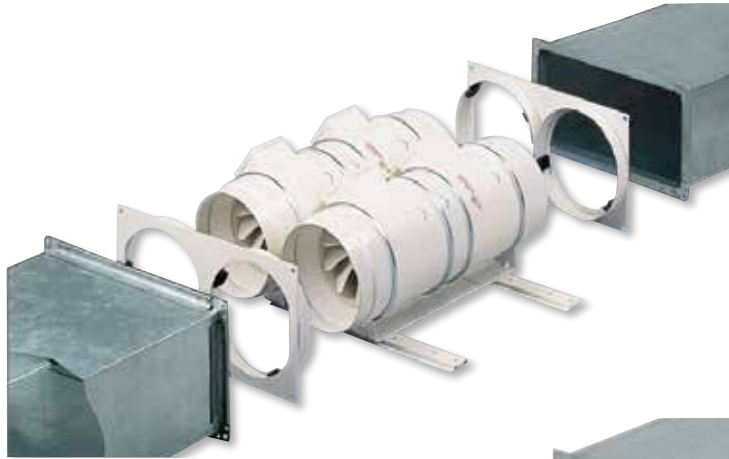

MIXVENT-TWINx2 system



MIXVENT-TWINx2 system with backdraft shutter fitted

The MIXVENT-Twinx2 consists of two MIXVENTTDx2 fans mounted in parallel using the Kit Twin Base (suitable from 350 to 1300 model). System specially recommended when a large airflow is required (at the same pressure) within a confined space, or where a supplementary airflow is occasionally needed. Once mounted, the whole assembly is ready to be connected to a rectangular duct using the two rectangular flanges supplied with the Kit Twin Base. The independent operation of two MIXVENTTDx2 requires the use of back draft shutters at the discharge (outlet) in order to prevent the air recycling through the stationary fan.

**ELEMENTS TO MOUNT
 MIXVENT-TWIN X 2 SYSTEM**

KIT TWIN BASE-350 + 2 TDx2-350/125
KIT TWIN BASE-500/150 + 2 TDx2-500/150
KIT TWIN BASE-500/160 + 2 TDx2-500/160
KIT TWIN BASE-800 + 2 TDx2-800/200
KIT TWIN BASE-1000 + 2 TDx2-1000/250
KIT TWIN BASE-1000 + 2 TDx2-1300/250

Backdraft shutter, see accessories page.

KIT TWIN BASE

This accessory consists of two rectangular duct couplings with standardized dimensions and two supports allowing mounting two TD or two TDx2 fans in parallel.

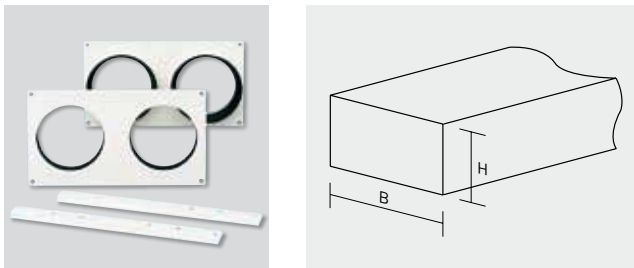

KIT TWIN BASE	Dimensions (mm)		Nominal dimensions of the rectangular duct (mm)	
	L	H	L	H
KIT TWIN BASE 250	320	180	280	140
KIT TWIN BASE 350	320	180	280	140
KIT TWIN BASE 500/150	395	220	355	180
KIT TWIN BASE 500/160	395	220	355	180
KIT TWIN BASE 800	440	240	400	200
KIT TWIN BASE 1000	540	290	500	250
KIT TWIN BASE 2000	690	355	630	315

Due to the isolated operation of TD models, backdraft shutters mounted at the outlet of TD fans are required in order to avoid the backdraft of air when the fan is not operating.

PERFORMANCE CURVES

- q_v : Airflow in m^3/h and m^3/s .
- p_{sf} : Static pressure in mmWG and Pa.
- Dry air at 20°C and 760 mmHg.
- Performance data in accordance with ISO 5801 and AMCA 210-99 Standards.

- ① TWINx2-350
- ② TWINx2-500
- ③ TWINx2-800
- ④ TWINx2-1000
- ⑤ TWINx2-1300

