



VENT-100N to VENT-315N



VENT-355N and VENT-400N

Range of in-line duct centrifugal fans, manufactured from high grade corrosion resistant pressed galvanised steel and supplied as standard with a pre-wired wiring junction box and a robust mounting foot. All model include an enclosed type, single-phase external rotor motor with factory matched backward curved nonstalling impeller. (1) Models 355 and 400 are manufactured in sheet steel protected against corrosion by cataforesis primer and black polyester paint finish.

Motors

100N - 250N models: Motors are IP44, class B insulation with ball bearings and safety thermal overload protection.

315N model: motor is IP44, class F insulation with ball bearings and safety thermal overload protection.

355N and 400N models: Motors are IP54, class F, with ball bearings and safety thermal overload protection.

Electrical supply:

Single phase 230V-50/60Hz.

Three phase 230/400V-50Hz

(models 355N-T and 400N-T). (See characteristics chart).

All single-phase models are speed controllable by tension.

The three-phase models are speed controllable by frequency inverter

Additional Information

Impellers from 100 to 250 models are manufactured from injection moulded plastic.



Mounting foot

Supplied with unit as standard (100N-315N models).

TECHNICAL CHARACTERISTICS

Before installation check that the product electrical characteristics listed on the data plate label (voltage, power, frequency, etc.) match those of the intended electrical supply.

Model	Voltage (V-Hz)	Speed (rpm)	Maximum absorbed power (W)	Maximum absorbed current (A)	Maximum airflow (m³/h)	Sound pressure level** (dB(A))			Maximum ambient temperature (°C)	Weight (kg)	Wiring diagram* (nº)
						Inlet	Outlet	Radiated			
VENT-100N	230-50/60	2600	61	0,3	290	56	54	44	-20/+60	3	19
VENT-125N	230-50/60	2620	60	0,3	390	57	54	42	-20/+60	3	19
VENT-150N	230-50/60	2550	95	0,4	750	59	56	42	-20/+60	5	19
VENT-160N	230-50/60	2560	96	0,4	760	59	55	42	-20/+60	5	19
VENT-200N	230-50/60	2720	147	0,6	970	60	58	43	-20/+60	5	19
VENT-250N	230-50/60	2720	149	0,6	1.030	62	61	50	-20/+60	6	19
VENT-315N	230-50/60	2790	257	1,1	1.370	65	64	48	-20/+60	8	19
VENT-355N	230-50/60	1404	287	1,2	2.690	58	61	40	-40/+70	18,8	19
VENT-400N	230-50/60	1380	536	2,3	3.890	59	63	49	-40/+50	22,2	19
VENT-355N T	230/400-50	1400	290	1,4/0,8	2600	58	61	40	-40/+70	17	21
VENT-400N T	230/400-50	1400	450	1,9/1,1	3460	59	63	49	-40/+50	22	21

* See section of Wiring Diagrams.

** Sound pressure level in dB(A) measured at 1,5m, in free field condition, at the maximum air volume.

DIMENSIONS (mm)

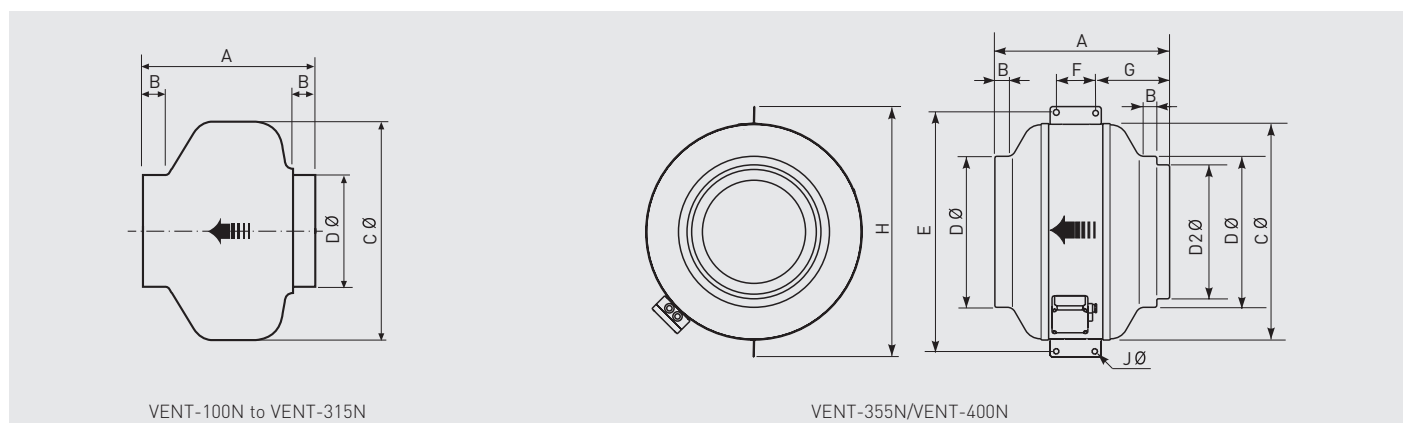

Model	A	B	C	D	D2	E*	F*	G*	H*	J*
VENT-100 N	195	23	243	98						
VENT-125 N	197	27	243	123						
VENT-150 N	213	22	333	147						
VENT-160 N	220	27	333	157						
VENT-200 N	223	25	333	198						
VENT-250 N	205	27	333	248						
VENT-315 N	232	25	401	312						
VENT-355 N	410	25	508	354	314	552	100	170	587	10,5
VENT-400 N	431	25	568	399	354	628	100	185	647	10,5

* Support brackets supplied in the packaging, not fitted on the fan.

PERFORMANCE CURVES - ACOUSTIC CHARACTERISTICS

- q_v : Airflow in m^3/h
- p_{sf} : Static pressure in Pa.
- P: Input power in W.
- SFP: Specific fan power in $W/m^3/s$ (blue curves)
- Performance data in accordance with ISO 5801.

VENT-100N

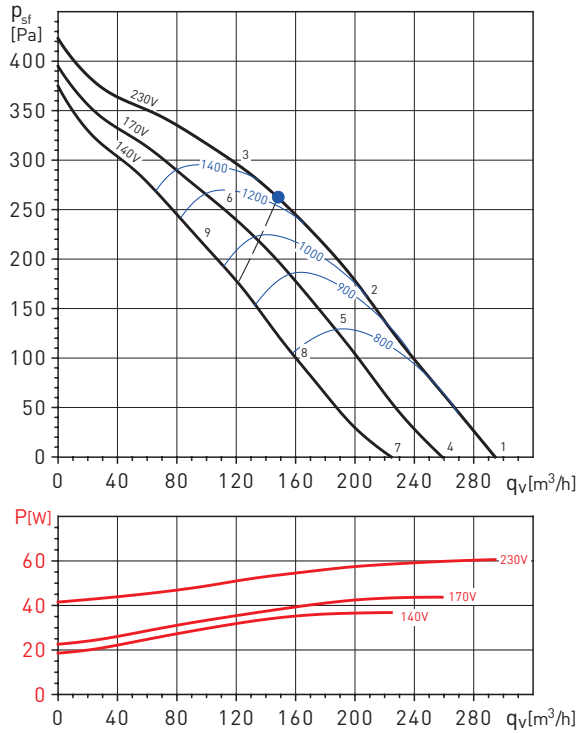

VENT-125N

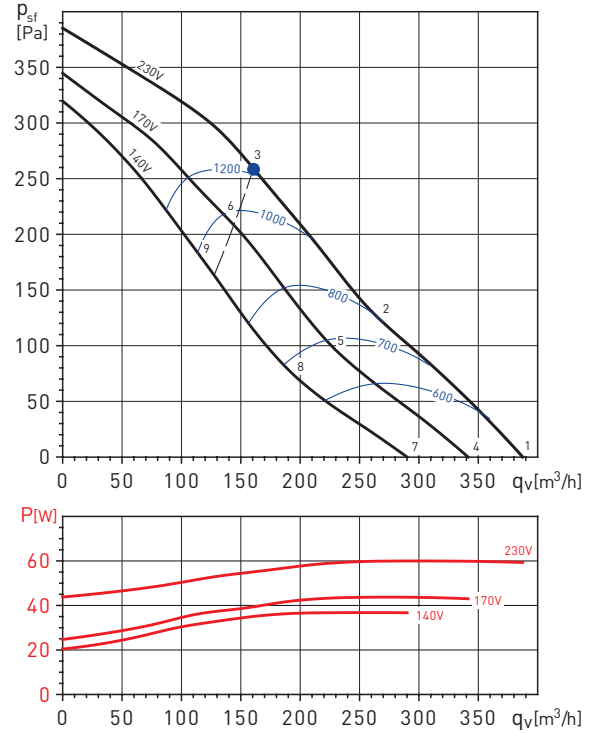

VENT-100N		63	125	250	500	1000	2000	4000	8000	LwA
1	Inlet	37	46	58	62	68	64	60	46	71
	Outlet	37	45	63	58	63	61	57	46	68
	Radiated	33	38	50	50	55	49	51	37	59
2	Inlet	39	45	56	60	66	62	56	43	69
	Outlet	38	44	61	56	61	59	54	43	66
	Radiated	35	37	48	48	53	47	47	34	56
3	Inlet	37	43	53	58	65	60	53	42	67
	Outlet	37	43	57	56	60	57	52	42	64
	Radiated	33	35	45	46	52	45	44	33	55
4	Inlet	35	43	55	59	65	61	56	41	68
	Outlet	35	42	60	55	60	58	53	41	65
	Radiated	31	35	47	47	52	46	47	32	55
5	Inlet	36	42	54	57	63	60	52	39	66
	Outlet	36	42	59	53	58	56	50	39	63
	Radiated	32	34	46	45	50	45	43	30	54
6	Inlet	34	40	52	56	63	58	50	39	65
	Outlet	35	41	56	53	58	55	49	40	62
	Radiated	30	32	44	44	50	43	41	30	53
7	Inlet	32	39	51	55	60	57	49	34	63
	Outlet	31	39	56	50	55	53	46	34	60
	Radiated	28	31	43	43	47	42	40	25	51
8	Inlet	32	38	49	53	59	55	45	32	62
	Outlet	32	39	54	49	54	51	44	32	59
	Radiated	28	30	41	41	46	40	36	23	49
9	Inlet	32	37	49	52	61	55	46	35	63
	Outlet	32	39	54	50	56	52	45	35	60
	Radiated	28	29	41	40	48	40	37	26	50

VENT-125N		63	125	250	500	1000	2000	4000	8000	LwA
1	Inlet	33	42	54	64	67	66	62	49	71
	Outlet	33	43	61	62	63	62	59	47	69
	Radiated	20	34	49	45	53	49	50	37	57
2	Inlet	34	42	53	64	66	64	58	47	70
	Outlet	34	43	59	62	62	60	56	45	67
	Radiated	21	34	48	45	52	47	46	35	55
3	Inlet	35	43	53	64	65	61	54	43	69
	Outlet	35	44	60	62	61	58	53	44	67
	Radiated	22	35	48	45	51	44	42	31	54
4	Inlet	31	40	52	62	65	64	60	47	69
	Outlet	31	41	59	60	61	60	57	45	66
	Radiated	18	32	47	43	51	47	48	35	55
5	Inlet	32	40	51	62	64	62	56	45	67
	Outlet	31	40	56	59	59	57	53	42	65
	Radiated	19	32	46	43	50	45	44	33	53
6	Inlet	33	41	51	62	63	59	52	41	67
	Outlet	33	42	58	60	59	56	51	42	65
	Radiated	20	33	46	43	49	42	40	29	53
7	Inlet	27	36	48	58	61	60	56	43	66
	Outlet	27	37	55	56	57	56	53	41	63
	Radiated	14	28	43	39	47	43	44	31	51
8	Inlet	28	36	47	58	60	58	52	41	64
	Outlet	28	37	53	56	56	54	50	39	61
	Radiated	15	28	42	39	46	41	40	29	49
9	Inlet	31	39	49	60	61	57	50	39	65
	Outlet	31	40	56	58	57	54	49	40	63
	Radiated	18	31	44	41	47	40	38	27	50

PERFORMANCE CURVES - ACOUSTIC CHARACTERISTICS

- q_v : Airflow in m^3/h
- p_{sf} : Static pressure in Pa.
- P: Input power in W.
- SFP: Specific fan power in $W/m^3/s$ (blue curves)
- Performance data in accordance with ISO 5801.

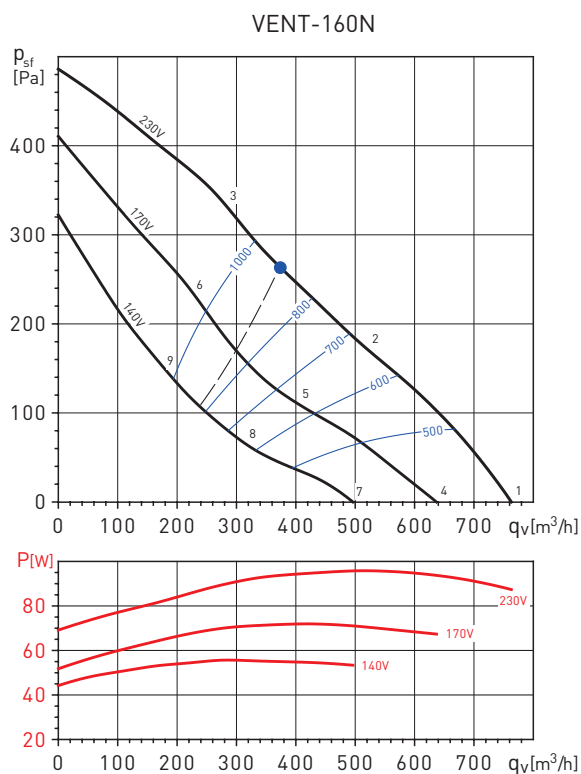
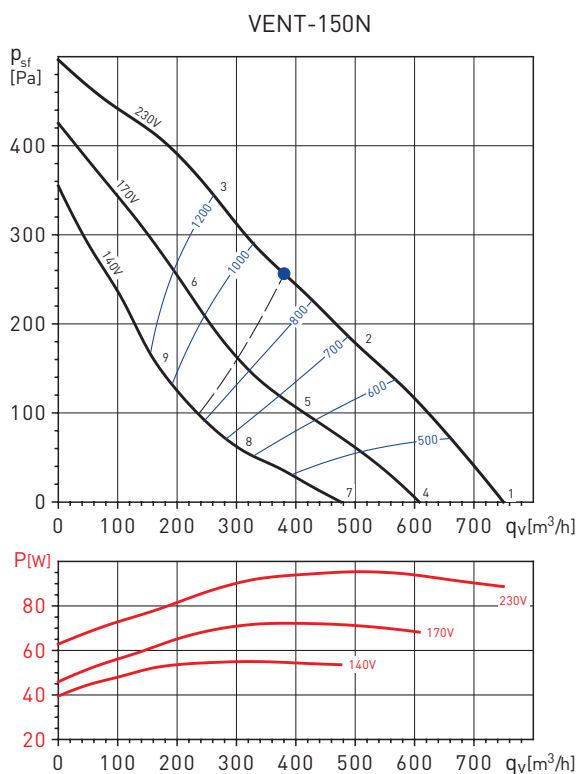

VENT-150N		63	125	250	500	1000	2000	4000	8000	LwA
1	Inlet	37	45	58	69	68	67	63	51	73
	Outlet	37	48	62	63	64	64	61	51	70
	Radiated	21	37	45	49	50	51	49	37	56
2	Inlet	35	44	58	68	67	65	60	48	72
	Outlet	35	47	59	62	63	63	58	48	69
	Radiated	19	36	45	48	49	49	46	34	55
3	Inlet	37	48	60	68	66	65	57	47	72
	Outlet	36	49	61	61	62	61	55	46	68
	Radiated	21	40	47	48	48	49	43	33	55
4	Inlet	33	41	54	65	64	63	59	47	70
	Outlet	33	44	58	59	60	60	57	47	66
	Radiated	17	33	41	45	46	47	45	33	52
5	Inlet	30	39	53	63	62	60	55	43	67
	Outlet	30	42	54	57	58	58	53	43	64
	Radiated	14	31	40	43	44	44	41	29	50
6	Inlet	33	44	56	64	62	61	53	43	68
	Outlet	33	46	58	58	59	58	52	43	64
	Radiated	17	36	43	44	44	45	39	29	51
7	Inlet	28	36	49	60	59	58	54	42	64
	Outlet	28	39	53	54	55	55	52	42	61
	Radiated	12	28	36	40	41	42	40	28	47
8	Inlet	24	33	47	57	56	54	49	37	62
	Outlet	24	36	48	51	52	52	47	37	58
	Radiated	8	25	34	37	38	38	35	23	44
9	Inlet	28	39	51	59	57	56	48	38	63
	Outlet	28	41	53	53	54	53	47	38	59
	Radiated	12	31	38	39	39	40	34	24	46

VENT-160N		63	125	250	500	1000	2000	4000	8000	LwA
1	Inlet	36	45	58	68	67	67	65	53	73
	Outlet	38	47	61	62	64	64	62	52	70
	Radiated	22	37	46	50	53	52	50	41	58
2	Inlet	33	45	57	68	67	65	61	50	72
	Outlet	34	47	57	63	63	63	58	49	69
	Radiated	19	37	45	50	53	50	46	38	57
3	Inlet	37	48	58	67	65	64	57	47	71
	Outlet	37	51	62	63	63	61	55	46	69
	Radiated	23	40	46	49	51	49	42	35	55
4	Inlet	32	41	54	64	63	63	61	49	69
	Outlet	34	43	57	58	60	60	58	48	66
	Radiated	18	33	42	46	49	48	46	37	54
5	Inlet	28	40	52	63	62	60	56	45	67
	Outlet	29	42	52	58	58	58	53	44	64
	Radiated	14	32	40	45	48	45	41	33	52
6	Inlet	33	44	54	63	61	60	53	43	67
	Outlet	33	47	58	59	59	57	51	42	65
	Radiated	19	36	42	45	47	45	38	31	51
7	Inlet	27	36	49	59	58	58	56	44	64
	Outlet	29	38	52	53	55	55	53	43	61
	Radiated	13	28	37	41	44	43	41	32	49
8	Inlet	22	34	46	57	56	54	50	39	62
	Outlet	24	37	47	53	53	53	48	39	58
	Radiated	8	26	34	39	42	39	35	27	46
9	Inlet	28	39	49	58	56	55	48	38	62
	Outlet	28	42	53	54	54	52	46	37	60
	Radiated	14	31	37	40	42	40	33	26	47

PERFORMANCE CURVES - ACOUSTIC CHARACTERISTICS

- q_v : Airflow in m^3/h
- p_{sf} : Static pressure in Pa.
- P: Input power in W.
- SFP: Specific fan power in $W/m^3/s$ (blue curves)
- Performance data in accordance with ISO 5801.

VENT-200N

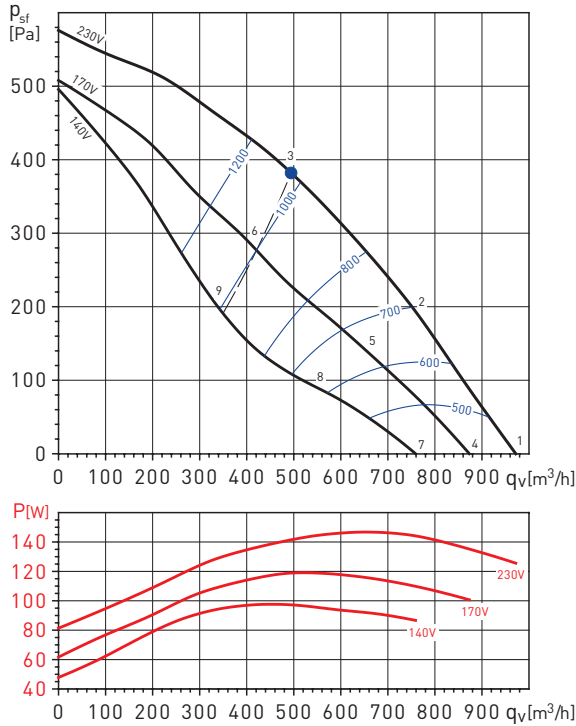

VENT-250N

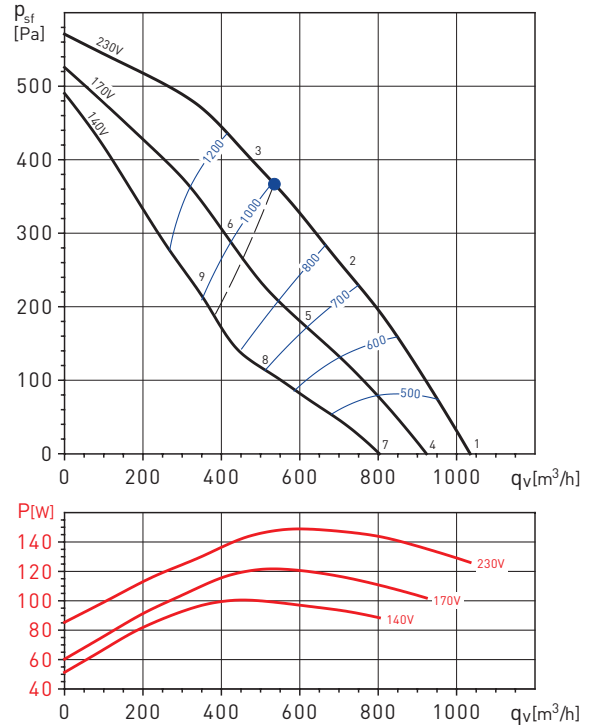

VENT-200N		63	125	250	500	1000	2000	4000	8000	LwA
1	Inlet	38	48	63	67	70	68	65	63	75
	Outlet	37	47	61	63	67	67	65	62	73
	Radiated	36	39	44	38	48	52	54	48	58
2	Inlet	36	46	62	64	67	64	61	55	71
	Outlet	37	46	62	61	63	63	61	54	69
	Radiated	34	37	43	35	45	48	50	40	54
3	Inlet	37	46	60	63	65	62	57	50	69
	Outlet	35	46	61	59	62	62	58	50	68
	Radiated	35	37	41	34	43	46	46	35	51
4	Inlet	36	46	61	65	68	66	63	61	73
	Outlet	36	46	60	62	66	66	64	61	71
	Radiated	34	37	42	36	46	50	52	46	56
5	Inlet	33	43	59	61	64	61	58	52	68
	Outlet	34	43	59	58	60	60	58	51	66
	Radiated	31	34	40	32	42	45	47	37	51
6	Inlet	34	43	57	60	62	59	54	47	67
	Outlet	32	43	58	56	59	59	55	47	65
	Radiated	32	34	38	31	40	43	43	32	48
7	Inlet	33	43	58	62	65	63	60	58	70
	Outlet	32	42	56	58	62	62	60	57	68
	Radiated	31	34	39	33	43	47	49	43	53
8	Inlet	29	39	55	57	60	57	54	48	64
	Outlet	30	39	55	54	56	56	54	47	62
	Radiated	27	30	36	28	38	41	43	33	47
9	Inlet	30	39	53	56	58	55	50	43	63
	Outlet	28	39	54	52	55	55	51	43	61
	Radiated	28	30	34	27	36	39	39	28	44

VENT-250N		63	125	250	500	1000	2000	4000	8000	LwA
1	Inlet	37	48	65	68	72	70	68	65	77
	Outlet	40	51	66	67	69	69	69	66	76
	Radiated	22	39	49	50	58	59	59	56	64
2	Inlet	36	46	63	64	68	66	66	59	73
	Outlet	39	49	63	63	65	64	66	59	72
	Radiated	21	37	47	46	54	55	57	50	61
3	Inlet	35	43	61	61	66	63	62	54	70
	Outlet	37	46	62	62	65	64	62	55	70
	Radiated	20	34	45	43	52	52	53	45	58
4	Inlet	35	46	63	66	70	68	66	63	74
	Outlet	38	49	64	65	67	67	67	64	74
	Radiated	20	37	47	48	56	57	57	54	62
5	Inlet	33	43	60	61	65	63	63	56	70
	Outlet	36	46	60	60	62	61	63	56	68
	Radiated	18	34	44	43	51	52	54	47	58
6	Inlet	32	40	58	58	63	60	59	51	67
	Outlet	34	43	59	59	62	61	59	52	67
	Radiated	17	31	42	40	49	49	50	42	55
7	Inlet	32	43	60	63	67	65	63	60	72
	Outlet	35	46	61	62	64	64	64	61	71
	Radiated	17	34	44	45	53	54	54	51	60
8	Inlet	28	38	55	56	60	58	58	51	65
	Outlet	31	41	55	55	57	56	58	51	64
	Radiated	13	29	39	38	46	47	49	42	53
9	Inlet	28	36	54	54	59	56	55	47	63
	Outlet	30	39	55	55	58	57	55	48	64
	Radiated	13	27	38	36	45	45	46	38	51

PERFORMANCE CURVES - ACOUSTIC CHARACTERISTICS

- q_v : Airflow in m^3/h
- p_{sf} : Static pressure in Pa.
- P: Input power in W.
- SFP: Specific fan power in $W/m^3/s$ (blue curves)
- Performance data in accordance with ISO 5801.

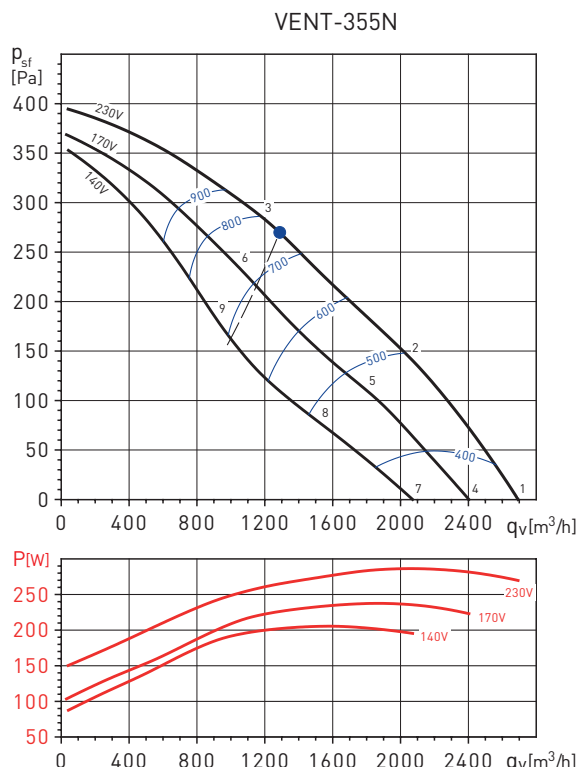
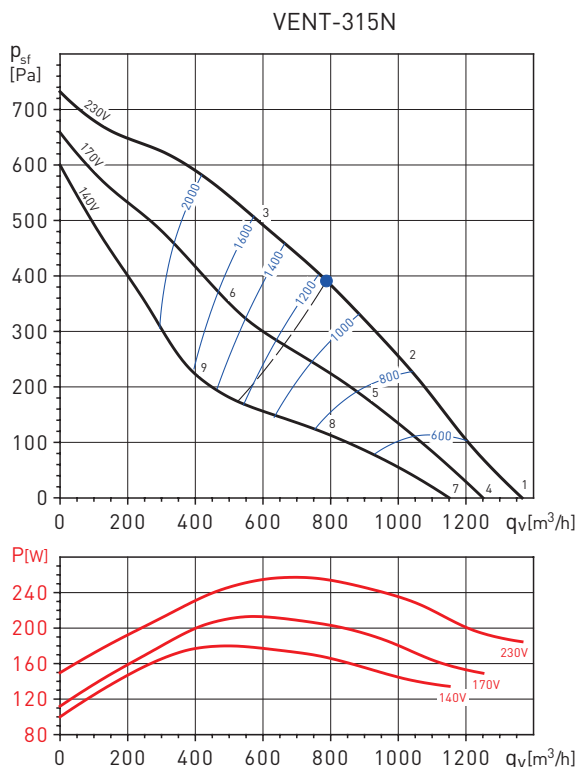

VENT-315N		63	125	250	500	1000	2000	4000	8000	LwA
1	Inlet	39	53	67	73	76	71	68	67	79
	Outlet	48	54	69	71	75	74	70	70	80
	Radiated	29	33	45	51	58	57	55	54	63
2	Inlet	38	55	67	73	73	69	67	63	78
	Outlet	49	55	70	71	74	72	69	64	79
	Radiated	28	35	45	51	55	55	54	50	61
3	Inlet	42	64	71	73	74	70	67	60	79
	Outlet	50	64	74	71	74	72	68	62	80
	Radiated	32	44	49	51	56	56	54	47	61
4	Inlet	38	52	66	72	75	70	67	66	78
	Outlet	47	53	68	70	74	73	69	69	79
	Radiated	28	32	44	50	57	56	54	53	61
5	Inlet	36	53	65	71	71	67	65	61	75
	Outlet	46	52	67	68	71	69	66	61	76
	Radiated	26	33	43	49	53	53	52	48	58
6	Inlet	39	61	68	70	71	67	64	57	76
	Outlet	47	61	71	68	71	69	65	59	76
	Radiated	29	41	46	48	53	53	51	44	58
7	Inlet	36	50	64	70	73	68	65	64	76
	Outlet	45	51	66	68	72	71	67	67	77
	Radiated	26	30	42	48	55	54	52	51	59
8	Inlet	31	48	60	66	66	62	60	56	71
	Outlet	42	48	63	64	67	65	62	57	72
	Radiated	21	28	38	44	48	48	47	43	54
9	Inlet	34	56	63	65	66	62	59	52	71
	Outlet	42	56	66	63	66	64	60	54	72
	Radiated	24	36	41	43	48	48	46	39	53

VENT-355N		63	125	250	500	1000	2000	4000	8000	LwA
1	Inlet	43	60	65	67	67	62	61	48	72
	Outlet	42	57	64	70	71	68	61	50	75
	Radiated	34	50	47	47	49	42	40	28	55
2	Inlet	39	57	63	65	66	60	57	48	70
	Outlet	39	55	64	70	69	66	58	49	74
	Radiated	30	47	45	45	48	40	36	28	53
3	Inlet	44	59	66	67	67	60	57	48	72
	Outlet	42	56	65	71	69	66	59	50	75
	Radiated	35	49	48	47	49	40	36	28	55
4	Inlet	41	58	63	65	65	60	59	46	70
	Outlet	40	55	62	68	69	66	59	48	73
	Radiated	32	48	45	45	47	40	38	26	53
5	Inlet	37	55	61	63	64	58	55	46	68
	Outlet	37	53	62	68	67	64	56	47	72
	Radiated	28	45	43	43	46	38	34	26	50
6	Inlet	42	57	64	65	65	58	55	46	70
	Outlet	40	54	63	69	67	64	57	48	73
	Radiated	33	47	46	45	47	38	34	26	53
7	Inlet	38	55	60	62	62	57	56	43	67
	Outlet	37	52	59	65	66	63	56	45	70
	Radiated	29	45	42	42	44	37	35	23	50
8	Inlet	33	51	57	59	60	54	51	42	65
	Outlet	33	49	58	64	63	60	52	43	68
	Radiated	24	41	39	39	42	34	30	22	47
9	Inlet	39	54	61	62	62	55	52	43	67
	Outlet	37	51	60	66	64	61	54	45	70
	Radiated	30	44	43	42	44	35	31	23	50

PERFORMANCE CURVES - ACOUSTIC CHARACTERISTICS

- q_v : Airflow in m^3/h
- p_{sf} : Static pressure in Pa.
- P: Input power in W.
- SFP: Specific fan power in $W/m^3/s$ (blue curves)
- Performance data in accordance with ISO 5801.

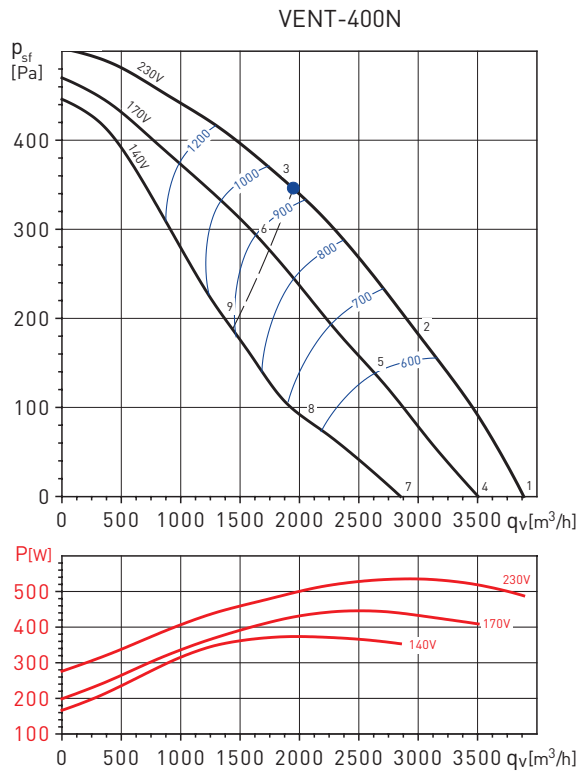

VENT-400N		63	125	250	500	1000	2000	4000	8000	LwA
1	Inlet	47	61	65	69	67	64	61	53	73
	Outlet	52	68	68	72	73	69	61	54	78
	Radiated	38	56	53	57	59	52	46	40	63
2	Inlet	43	58	62	64	64	62	57	50	70
	Outlet	44	66	64	67	69	65	57	49	74
	Radiated	34	53	50	52	56	50	42	37	60
3	Inlet	46	60	64	66	64	60	55	50	71
	Outlet	47	65	65	68	68	63	55	47	73
	Radiated	37	55	52	54	56	48	40	37	61
4	Inlet	45	59	63	67	65	62	59	51	71
	Outlet	50	66	66	70	71	67	59	52	76
	Radiated	36	54	51	55	57	50	44	38	61
5	Inlet	40	55	59	61	61	59	54	47	67
	Outlet	41	63	61	64	66	62	54	46	71
	Radiated	31	50	47	49	53	47	39	34	57
6	Inlet	44	58	62	64	62	58	53	48	69
	Outlet	45	63	63	66	66	61	53	45	71
	Radiated	35	53	50	52	54	46	38	35	59
7	Inlet	41	55	59	63	61	58	55	47	67
	Outlet	46	62	62	66	67	63	55	48	72
	Radiated	32	50	47	51	53	46	40	34	57
8	Inlet	35	50	54	56	56	54	49	42	62
	Outlet	36	58	56	59	61	57	49	41	66
	Radiated	26	45	42	44	48	42	34	29	52
9	Inlet	40	54	58	60	58	54	49	44	65
	Outlet	41	59	59	62	62	57	49	41	67
	Radiated	31	49	46	48	50	42	34	31	55

PERFORMANCE CURVES - ACOUSTIC CHARACTERISTICS

- q_v : Airflow in m^3/h
- p_{sf} : Static pressure in Pa.
- P: Input power in W.
- SFP: Specific fan power in $W/m^3/s$ (blue curves)
- Performance data in accordance with ISO 5801.

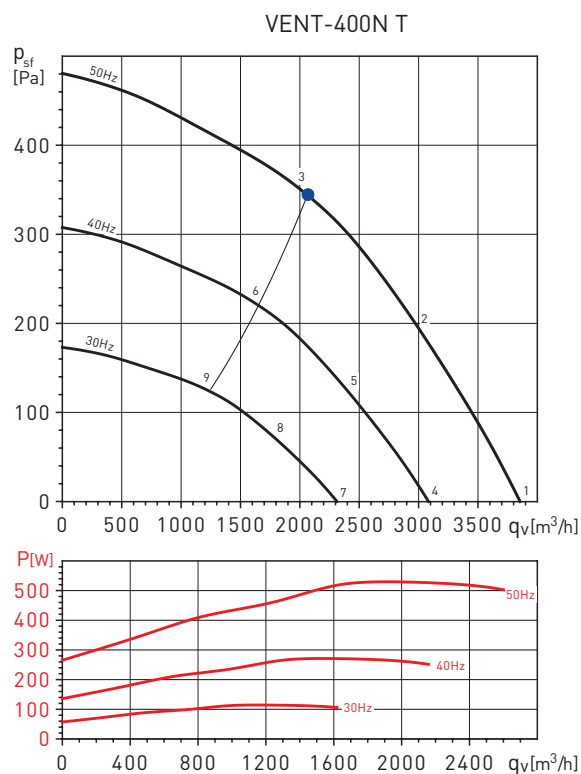
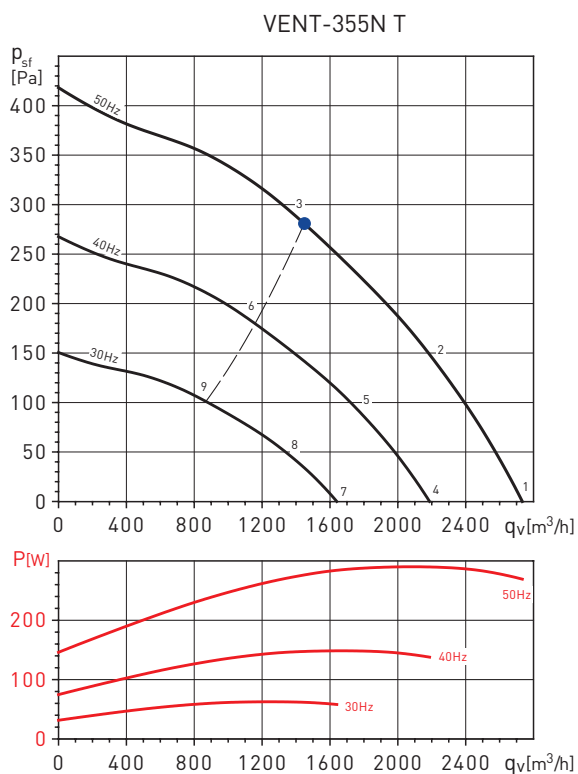

VENT-355N T		63	125	250	500	1000	2000	4000	8000	LwA
1	Inlet	43	60	65	67	67	62	61	48	72
	Outlet	42	57	64	70	71	68	61	50	75
	Radiated	34	50	47	47	49	42	40	28	55
2	Inlet	39	57	63	65	66	60	57	48	70
	Outlet	39	55	64	70	69	66	58	49	74
	Radiated	30	47	45	45	48	40	36	28	53
3	Inlet	44	59	66	67	67	60	57	48	72
	Outlet	42	56	65	71	69	66	59	50	75
	Radiated	35	49	48	47	49	40	36	28	55
4	Inlet	38	55	60	62	62	57	56	43	67
	Outlet	37	52	59	65	66	63	56	45	70
	Radiated	29	45	42	42	44	37	35	23	50
5	Inlet	34	52	58	60	61	55	52	43	66
	Outlet	34	50	59	65	64	61	53	44	69
	Radiated	25	42	40	40	43	35	31	23	48
6	Inlet	39	54	61	62	62	55	52	43	67
	Outlet	37	51	60	66	64	61	54	45	70
	Radiated	30	44	43	42	44	35	31	23	50
7	Inlet	32	49	54	56	56	51	50	37	61
	Outlet	31	46	53	59	60	57	50	39	64
	Radiated	23	39	36	36	38	31	29	17	44
8	Inlet	28	46	52	54	55	49	46	37	59
	Outlet	28	44	53	59	58	55	47	38	63
	Radiated	19	36	34	34	37	29	25	17	42
9	Inlet	33	48	55	56	56	49	46	37	61
	Outlet	31	45	54	60	58	55	48	39	64
	Radiated	24	38	37	36	38	29	25	17	44

VENT-400N T		63	125	250	500	1000	2000	4000	8000	LwA
1	Inlet	47	61	65	69	67	64	61	53	73
	Outlet	52	68	68	72	73	69	61	54	78
	Radiated	38	56	53	57	59	52	46	40	63
2	Inlet	43	58	62	64	64	62	57	50	70
	Outlet	44	66	64	67	69	65	57	49	74
	Radiated	34	53	50	52	56	50	42	37	60
3	Inlet	46	60	64	66	64	60	55	50	71
	Outlet	47	65	65	68	68	63	55	47	73
	Radiated	37	55	52	54	56	48	40	37	61
4	Inlet	42	56	60	64	62	59	56	48	68
	Outlet	47	63	63	67	68	64	56	49	73
	Radiated	33	51	48	52	54	47	41	35	58
5	Inlet	38	53	57	59	59	57	52	45	65
	Outlet	39	61	59	62	64	60	52	44	69
	Radiated	29	48	45	47	51	45	37	32	55
6	Inlet	41	55	59	61	59	55	50	45	66
	Outlet	42	60	60	63	63	58	50	42	68
	Radiated	32	50	47	49	51	43	35	32	56
7	Inlet	36	50	54	58	56	53	50	42	62
	Outlet	41	57	57	61	62	58	50	43	67
	Radiated	27	45	42	46	48	41	35	29	52
8	Inlet	32	47	51	53	53	51	46	39	59
	Outlet	33	55	53	56	58	54	46	38	63
	Radiated	23	42	39	41	45	39	31	26	49
9	Inlet	35	49	53	55	53	49	44	39	59
	Outlet	36	54	54	57	57	52	44	36	62
	Radiated	26	44	41	43	45	37	29	26	50

MOUNTING ACCESSORIES



MBE
Electric heater.



MBW
Hot water coil.



SIL
Circular sound attenuators.



MFL-G4
Filtration box of G4 grade filtration.

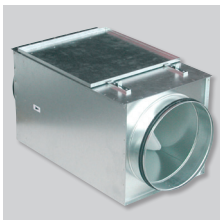

MFL-F
Box in galvanized steel for inserting the MFR F5, F6 and F7 filters.



Mounting foot
(supplied with unit as standard).



ACOP-VENT
Flexible connectors.



DEF-VENT
Protection grille.



GSA M0
Aluminium flexible ducting.



GSI M0
Insulated aluminium ducting.



CX
Worm drive duct connectors.



BOR
Metal inlet valves.



BOR
Plastic inlet valves.



GCI
Circular inlet grilles.



GRI
Interior square grilles.



VR
GCI mounting frame.

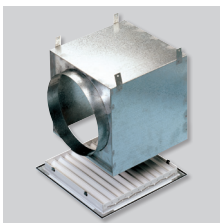

RP
GRI mounting frame.

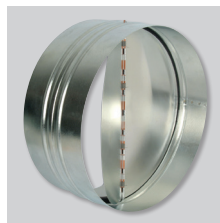

CAR
Backdraught shutters.

For more information see Mounting accessories.

ELECTRICAL ACCESSORIES



REB
Electronic single phase speed controllers.



RMB
Autotransformer single phase speed controllers.



PARO/MARCHA 5P and 8P
ON/OFF electrical isolation switch.



PULSER
Electric heater controllers for 1Ph models up to 3600W and 3Ph models up to 6400W.



TTC 2000
Electric heater controllers for 3 phase models.



TG-K
Duct temperature sensor.



TG-R
Room wall mounted temperature sensor.

For more information see Electrical accessories.